

▶ WMF72  
User Manual

## Thank you for purchasing this product.

For optimum performance and safety, please read these instructions carefully before connecting, operating or adjusting this product. Please keep this manual for future reference.



### Surge Protection Device Recommended

This product contains sensitive electrical components that may be damaged by electrical spikes, surges, electric shock, lightning strikes, etc. Use of surge protection systems is highly recommended in order to protect and extend the life of your equipment.



### Eco Friendly Packaging

This product has been packaged with fully recyclable materials, including compostable bags. Please help us to help the environment.

## Contents

Introduction	04
Front Panel Description	05
Rear Panel Description	05
Side Panel Description	06
Resetting	06
Operation and Connections	07
Wired Connectivity	07
BYOD Connectivity	08
Wireless Dongle Connectivity	08
Wireless Dongle Control	09
Touchback Control of a Connected Device	09
WMF Control App Connectivity	10-12
Interactive Display Control	13-17
Dual HDMI Output Connectivity	18-19
USB 3.0 Hub & USB Sharing	19-20
Network Connectivity Options	21-24
Network Configuration	25
Web-GUI - Login and Initialisation	26
Web-GUI - Control Page	27-28
Web-GUI - Input Page	29
Web-GUI - Output Page	30-32
Web-GUI - USB Page	33-34
Web-GUI - Multiview Page	34
Web-GUI - Settings Page	35-42
Web-GUI - Firmware Update Page	43



## Contents (continued)

Web-GUI - Password Update Page .....	43
Web-GUI - Information Page .....	44
Web-GUI - Apps Page .....	44
Specifications, Contents, Maintenance .....	45
RS-232 & Telnet Commands .....	46-48
Certifications .....	49

# Introduction

The WMF72 is an advanced 4K multi-format presentation switch featuring wired HDMI and USB-C, AirPlay, Miracast® and Chromecast® inputs to dual HDMI outputs.

The WMF72 provides enhanced features including dual HDMI output for mirrored or managed source control with multiview presentation, video scaling and web-GUI for control and configuration, localised 2.4/5G Wi-Fi access point, and dual LAN connection. The WMF72 also features OSD control, USB camera and MIC over Wi-Fi, USB touch-back to connected host device, whiteboard and screen overlay annotation, manual or automated source selection, and control via front panel, RS-232 and TCP/IP.

The WMF72 is also compatible with Blustream WMF-USBC-D and WMF-HDMI-D plug & play wireless dongles, providing an ideal BYOD solution for your boardroom, classroom or huddle-space application.

---

## FEATURES:

---

- 4K multi-format multi-view presentation switch
- Features HDMI, USB-C, AirPlay, Miracast®, Chromecast® and Blustream wireless dongle support which can be switched to dual HDMI outputs
- Dual HDMI output supports mirror or desktop extension for managed source control within advanced video conferencing setups
- Multiview presentation with up to 5 concurrent video signals and configurable screen layout
- In-built video scaler with Main output timing up to 4K 60Hz 4:4:4, and Sub output timing up to 1080p 60Hz
- USB-C connection for BYOM, with DP, USB, 1Gbps network and up to 65W power charging
- HDMI & USB Type B connection for BYOM, with USB and 1Gbps network via USB Type B connection
- Localised 2.4G/5G Wi-Fi access point to host AirPlay, Miracast® and Chromecast® local point-to-point mode (up to 1080p 30Hz)
- Dual LAN connection for integration to existing network infrastructures
- Supports USB camera and MIC over t up (1080p 30Hz)
- Supports USB touch-back feature via WMF-USBC-D and WMF-HDMI-D dongles and Miracast®\*
- Audio breakout to balanced / unbalanced analogue L/R audio
- Web interface module for control and configuration of switch
- OSD control with preview function
- Whiteboard canvas and screen overlay annotation feature
- Control via front panel, RS-232 and TCP/IP with manual, or auto source selection

**Please note:** \*Miracast® touch-back compatibility subject to Windows features



# WMF72 Front Panel Description

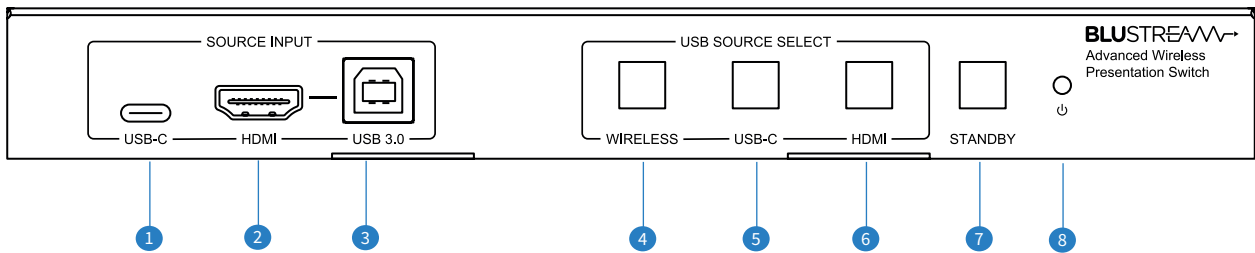

- 1 USB-C source input port: for video (DP Alt Mode) and USB 3.0 data from a wired source/host device
- 2 HDMI source input port: for video from a wired source device
- 3 USB-B source input port: for USB data from a wired source device (used in conjunction with the HDMI port for video)
- 4 Wireless USB source selection button: set the wireless device as the selected USB host
- 5 USB-C USB source selection button: set the USB-C device as the selected USB host
- 6 HDMI (USB-B) USB source selection button: set the HDMI (USB-B) device as the selected USB host
- 7 Standby button: press to toggle the unit in and out of standby (LED remains lit blue when device is receiving power, regardless of whether the unit is in standby)
- 8 Power LED indicator: indicates if the unit is powered

# WMF72 Rear Panel Description

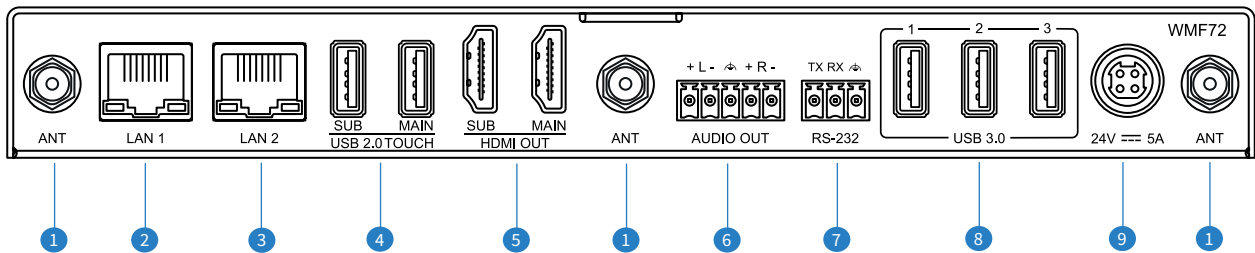

- 1 Wi-Fi Antenna Connections (x3): connect to supplied Wi-Fi antenna
- 2 LAN 1 TCP/IP Port: 1Gbps RJ45 connector to connect to primary network (i.e. split Corporate/Guest network)
- 3 LAN 2 TCP/IP Port: 1Gbps RJ45 connector to connect to secondary network (i.e. split Corporate/Guest network)
- 4 USB Touchback sub/main: dual USB ports for connection to dual interactive displays for touchback capabilities to connected host device. **Please note:** these USB ports are only for connection to an interactive display for touchback capabilities
- 5 HDMI Outputs sub/main: dual HDMI outputs to connect to HDMI displays
- 6 Analogue Audio Left/Right Output: balanced/unbalanced audio output to de-embed stereo audio from the WMF72
- 7 RS-232 port: for control of the hub from a 3rd party control processor or PC (Phoenix connector included)
- 8 USB 3.0 ports: for connection of camera/speaker/mic VC equipment to be passed to the connected host device
- 9 Power port: use supplied Blustream 24V/5A DC adaptor to power the device

## WMF72 Side Panel Description

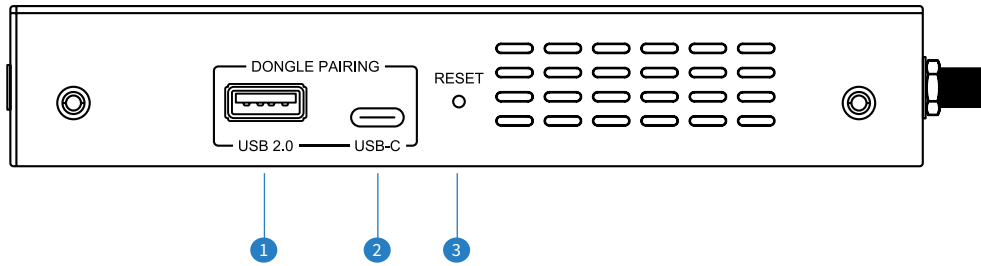

① USB-A dongle pairing port: used to pair the WMF-HDMI-D dongle with the WMF72 hub (USB connection only required for pairing). The WMF72 video output will display information regarding the automatic pairing and firmware update process.

**Please note:** wireless dongles sold separately

② USB-C dongle pairing port: used to pair the WMF-USBC-D dongle with the WMF72 hub

③ Reset: see below for further information on how to reset the WMF72

## Resetting the WMF72

To reset the WMF72 back to factory default, insert a small instrument to press down the recessed button on the side of the unit labelled RESET. If connected to a display, two options will be presented: 'Factory Reset', or 'Cancel', press the reset button in again to factory reset the device. The reset process takes approximately 30 seconds during which time the power LED on the front will show either red or blue, but there will be no output to the connected display. If using an interactive panel connected via HDMI and USB, you can select 'Factory Reset', or 'Cancel' on screen as required.

# Operation and Connections

To achieve basic operation, connect a display to the HDMI Main out, attach the three Wi-Fi antennas, and connect the power supply to the rear of the unit before powering on. After the WMF72 has initialised, the home screen background will be displayed on the HDMI output:



The default home background lists the various ways to connect an input to the WMF72.

Various UI overlay elements are visible whilst the home screen background is being displayed

- main, sub label to identify the HDMI output
- time display, configurable in the Web-GUI to be set automatically or manually
- device SSID and Passkey
- LAN IP and Wi-Fi IP

These can be turned on or off using the web-GUI.

## Wired Connectivity

The WMF72 features two dedicated wired inputs on the front of the unit via USB-C and via HDMI & USB-B.

The USB-C port features DP Alt Mode, USB sharing, 1Gbps network pass-through, touchback control, and up to 65W power charging.

The HDMI port can be used independently from the USB-B port, however USB-B connection is required for USB sharing, and 1Gbps network pass-through and touchback control.

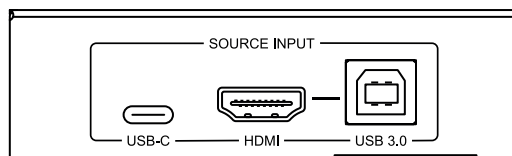

## Bring Your Own Device (BYOD) Connectivity

There are various technologies utilised to ensure your smart device is capable of broadcasting video to the WMF72 without the requirement for any apps. These are:

Technology	Device	Max Simultaneous Connections
Airplay	Apple devices	2
Miracast®, SmartView, or ScreenCast	Windows 10/11, Android devices	2
Chromecast®	Google devices	2

Up to 5 simultaneous wireless streams can be displayed, corresponding to the 5 multiview windows (e.g., 2 x Airplay, 2x Miracast®, 1 x Chromecast®).

**Please note:** The wireless technologies built into this unit have been designed for the sharing of content from source devices in corporate environments which include Power Point presentations, basic video content, imagery etc. The WMF72 has not been designed to stream on-demand content from a webpage / browser / app.

**Please note:** Airplay uses DRM (Digital Rights Management) from an Apple OS / iOS source device such as a Mac or iPad. DRM is the use of technology to control and manage access to copyrighted material. The use of DRM may limit the capabilities of an Apple device to output certain pieces of media to the WMF72. This cannot be circumnavigated.

**Please note:** In order for the Chromecast feature to work reliably, the time zone of the WMF72 and your source device must match.

## Wireless Dongle Connectivity

The WMF72 hub supports screen sharing via WMF-USBC-D and WMF-HDMI-D wireless dongles (purchased separately). These dongles allow laptops and PC's with HDMI or USB-C connectivity to wirelessly screen share with the WMF72. The dongles are intended for use where devices either are not capable of wireless sharing, or where wireless network connectivity of their device is not possible.

There is no restriction on the total number of dongles that can be paired with the WMF72. When in Access Point mode, up to 16 dongles can be connected at any one time. When in Wireless Infrastructure mode or LAN Infrastructure mode, up to 50 dongles can be connected at any one time.

To pair the WMF dongles, simply plug the USB-C (WMF-USBC-D) or the USB-A (WMF-HDMI-D) into the appropriate port on the side of the WMF72 labelled 'Dongle Pairing' for automatic pairing. The progress of the pairing is displayed on the screen connected to the HDMI output of the WMF72. The firmware of the dongles will be updated via the WMF72 automatically during the pairing process.

Once pairing is successful, the on screen display will update, and the light on the dongle will turn green.

**Please note:** do not remove the dongle from the WMF72 hub during the pairing process. If the firmware of the WMF72 has been updated, re-pairing of any wireless dongles will also be required.

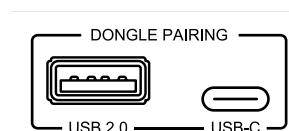

## Wireless Dongle Control

Once paired, the Blustream WMF-HDMI-D or WMF-USBC-D dongles can be connected to the USB-C or HDMI/USB connections of a laptop or compatible mobile device.

On connection of the dongle to the source device, the LED will flash red whilst the unit boots up and is discovered by the WMF72 hub. Once the dongle is ready to share, the LED will stop flashing and will have a solid red light.

### Share button:

The Share button allows the user to share the output from their display to the WMF72 hub via the connected dongle. Once the LED on the dongle is solid red, press the large button marked 'Share' to wirelessly send the content from your device to the WMF72. Once the dongle is sharing media, the LED will turn green until such point as the wireless connection is stopped (by pressing 'Share' again), or physically disconnecting the dongle.

Press and hold Share button: by pressing and holding the share button the user can make the source device full screen if the output is in Multiview mode.

**Please note:** many laptops may only allow for one additional display to be connected. Where applicable, connecting a Blustream dongle to a laptop that already has a HDMI connection to a display may stop the dongle from being discovered by the WMF72 hub.

### Freeze button:

The Freeze button allows the user to pause the video content being distributed from the device to the WMF72 hub. Pressing this button holds onto the last frame of video giving the user the opportunity to change to a different presentation / file in the background. Pressing the Freeze button again, resumes video content playback in real time.

### Custom button:

The Custom button can be programmed to provide specific functionality of the WMF72 to be triggered from the dongle. Customisation of this button is programmed via the WMF72 web-GUI (see page 36).

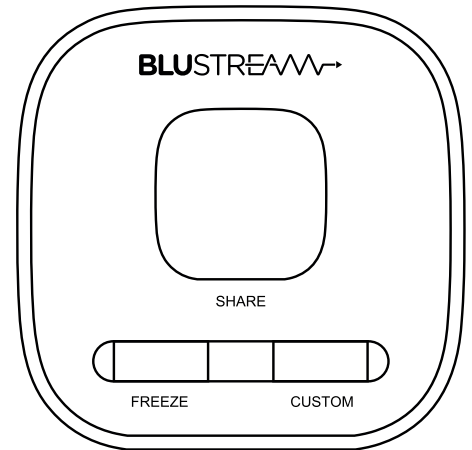

## Touchback Control of a Connected Device

Basic touchback control can be enabled when using interactive display(s) for a presenter to be able to control the WMF72 and the connected device. The WMF72 supports dual output connectivity and separate touch back for output.

Connect a USB cable between the USB Touchback port on the WMF72 and the display. It is essential to ensure that both the HDMI and USB cables are properly connected to the corresponding main or sub ports. For example, the primary display should have both HDMI and USB cables connected to the "Main" ports, while the secondary display should have both cables connected to the "Sub" ports.

The USB touchback ports also support keyboard/mouse roaming; by connecting a keyboard/mouse to either touchback port, you can control the sources in both the Main and Sub display.

Some points to note with touchback control:

- A virtual mouse is created when using touchback for controlling the connected source. The black mouse pointer is generated between the WMF72 and interactive panel, the white mouse pointer is the standard mouse from the connected computer.
- To 'right click' the mouse on an interactive panel, press and hold the screen (this is standard for most touch panels, but may differ between brands).
- For touchback to work on Apple Mac devices, you may have to enable the devices accessibility feature for touchback to work. This can be found within Settings / Privacy & Security / Accessibility section under Mac OS.
- When using an Apple Mac, the Mac must be set to Mirror as the touchback will only control the main desktop. When setting display settings to 'extend', the mouse will still only control the main desktop.

## WMF Control App Connectivity

The WMF72 can be shared to wirelessly using the Blustream WMF control app, this can be downloaded from the App page on the Web-GUI, from the product page on the Blustream website or installed from a connected dongle (shown below).

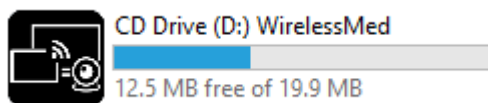

The Windows/MacOS app also allows wireless use of USB peripheral devices (camera/speakers/mic) that are connected to the WMF72.

### WMF72 App for Windows and MacOS

When the WMF72 app is run for the first time it will scan the network for WMF72 devices and list the names of any devices found. The default device name is WMF72 plus the last 4 digits of the MAC address, this name can be viewed on screen. Select “Connect” next to the device and enter the password from the screen when prompted to connect

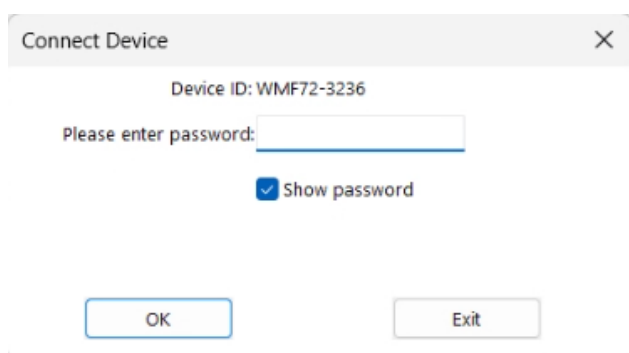

### Virtual drivers for wireless USB sharing (optional)

Wireless use of USB devices connected to the WMF72 (camera/speakers/mic) requires use of the App as well as installation of the virtual drivers. Each time the app is run the user will be prompted to install the virtual drivers unless 1) they are already installed or 2) “Show at startup” is unticked.

The virtual driver is not required for screen sharing but is required to wirelessly use the USB camera/speakers/mic peripherals connected to the WMF72.

Installation can be started by clicking “Yes” when prompted in the popup window, local installation will begin and this might require admin rights on the device where it’s being installed.

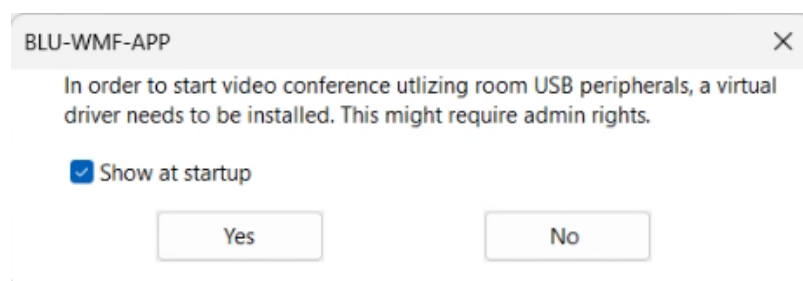

Once installed “virtual” devices will be available for use in meeting software, when joining a meeting select “Virtual Meeting Camera” and “Virtual Meeting Audio” which wirelessly connects to the USB devices attached to the WMF72 and allows use of these remote USB peripherals on the local device.

## WMF72 App for Windows and MacOS (continued)

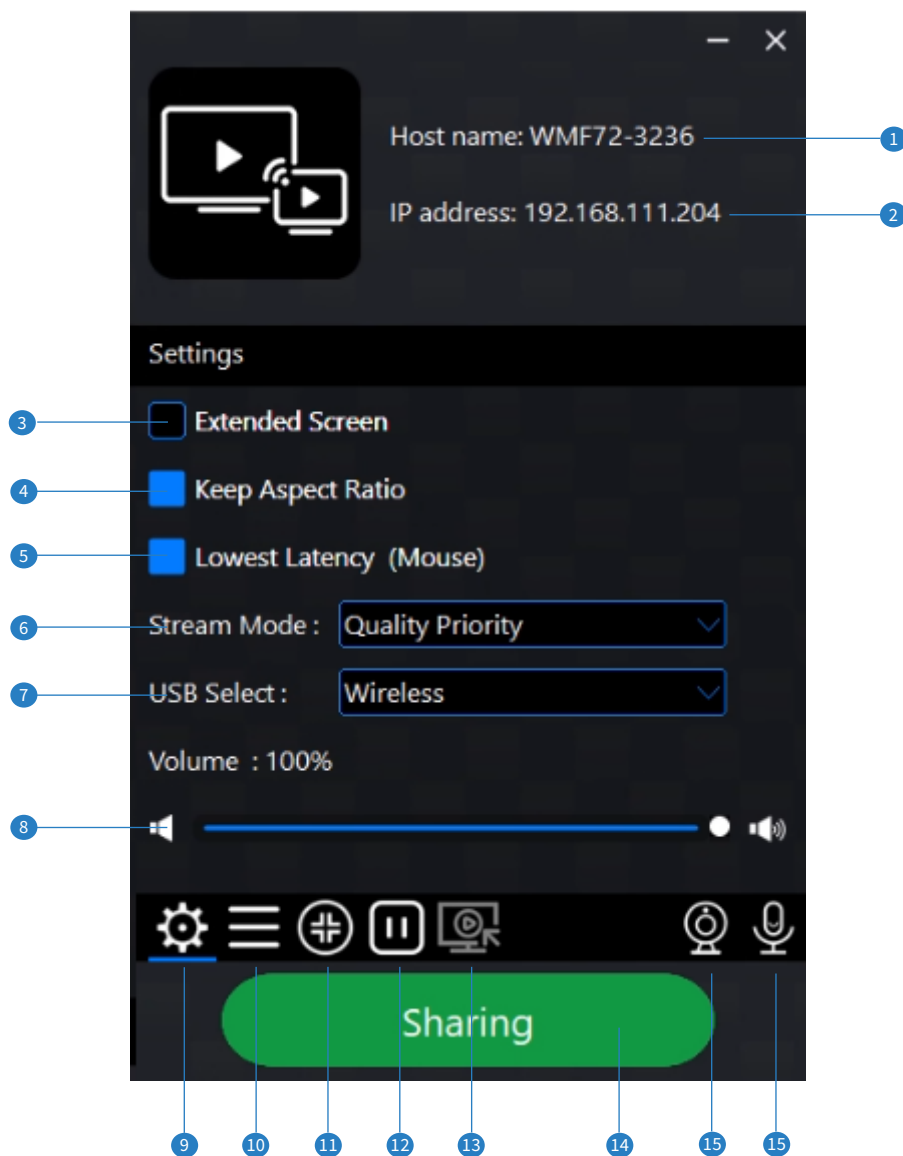

- ① Hostname: Shows the hostname of the connected WMF72
- ② IP address: Shows the IP address of the connected WMF72
- ③ Extended Screen: This mode will allow sharing a “virtual” extended desktop instead of the main desktop (this feature requires installation of an additional virtual driver, installation will be prompted when enabling the feature)
- ④ Keep Aspect Ratio: Select to maintain the aspect ratio or stretch to fill the screen/zone when sharing to the WMF72
- ⑤ Enable/Disable Low Latency Mouse mode
- ⑥ Streaming Mode: Select to prioritise video quality or frame rate
- ⑦ USB selection: Select between wired/wireless hosts for connectivity to the USB devices (also adjustable from the GUI or the button on the front of the WMF72)
- ⑧ Volume: Control the volume of the source being shared to the WMF72
- ⑨ Settings: Open/close settings page of the app shown above
- ⑩ Device List: Show the WMF device list, allowing connection to a different WMF72 device
- ⑪ Switch between full screen and split screen mode (where there are multiple devices connected and sharing content)
- ⑫ Pause/Play the screen sharing on the WMF72, allows freezing the current image on screen
- ⑬ View the content from the WMF72 on the local device, allowing users to view presentations currently being shared by other users locally
- ⑭ Start/Stop sharing content from the local device to the WMF72
- ⑮ USB peripheral icons: Shows availability of connected USB camera/speaker/mic peripherals, icons will be green when in use



**WMF72 App for Windows and MacOS (continued)**

By pressing the Start/Stop sharing content button (13), the WMF72 is able to display content playback via LAN on the host device.

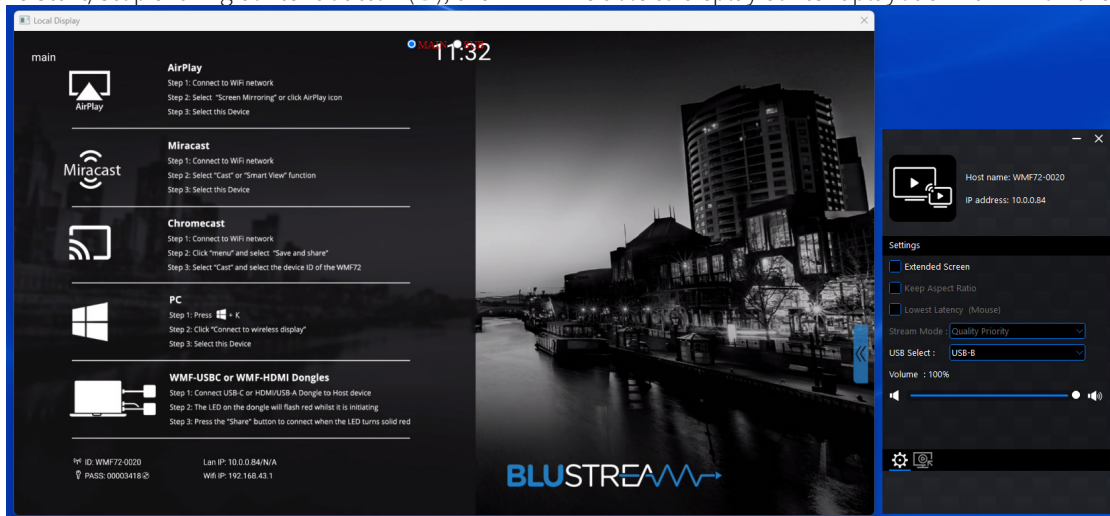

The Main or Sub display can be viewed from the options at the top centre of the window. A maximum of two sharing sources is recommended for the best content playback experience. When more than two sources are sharing content, this feature can't be activated.

**WMF72 App for Android**

When the WMF72 Android app is run for the first time it will scan the network for WMF72 devices and list the names of any devices found. The default device name is WMF72 plus the last 4 digits of the MAC address, this name can be viewed on screen. Select the WMF72 device to connect to and enter the password from the screen when prompted to connect.

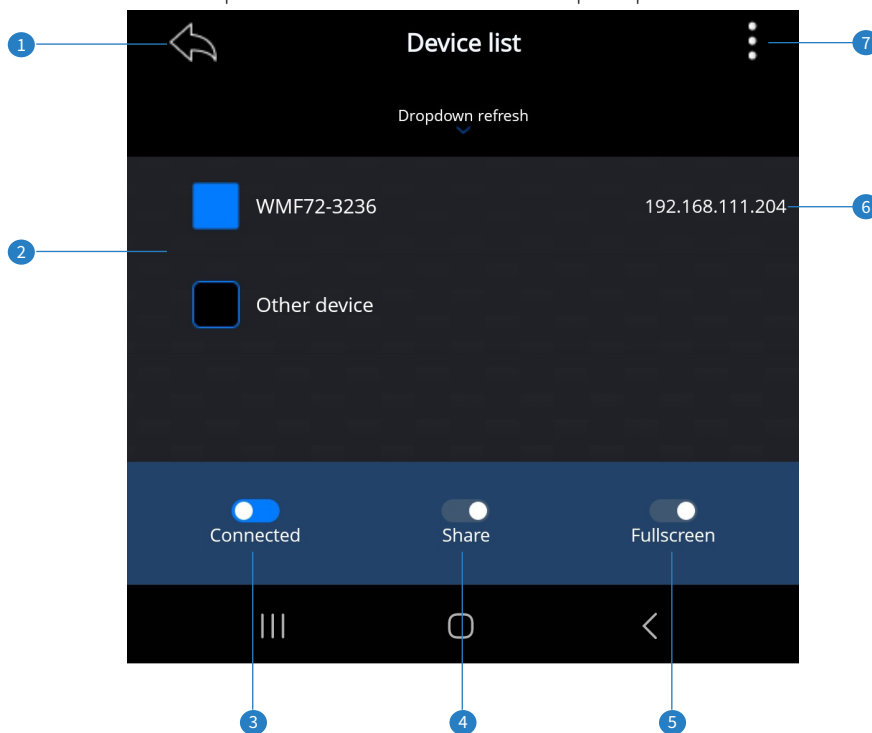

- 1 Exit: Stop sharing and exit the Android application
- 2 Device List: List of WMF72 devices found on the network, choose a device to connect to which is then highlighted as selected/ connected in the list (enter the password to connect when prompted)
- 3 Connected: Shows current connection status to a WMF72, pressing will disconnect the device from the WMF72
- 4 Share: Start/Stop sharing content from the local device to the WMF72
- 5 Fullscreen: Switch between full screen and split screen mode (where there are multiple devices connected and sharing content)
- 6 IP address: Shows the IP address of the connected WMF72
- 7 About: Show the about page of the app to view the current app version



# Interactive Display Control

The WMF72 has on-screen control options for a presenter to utilise when connected to an interactive panel. The blue tab on the right had side of the display opens / closes the control options available:

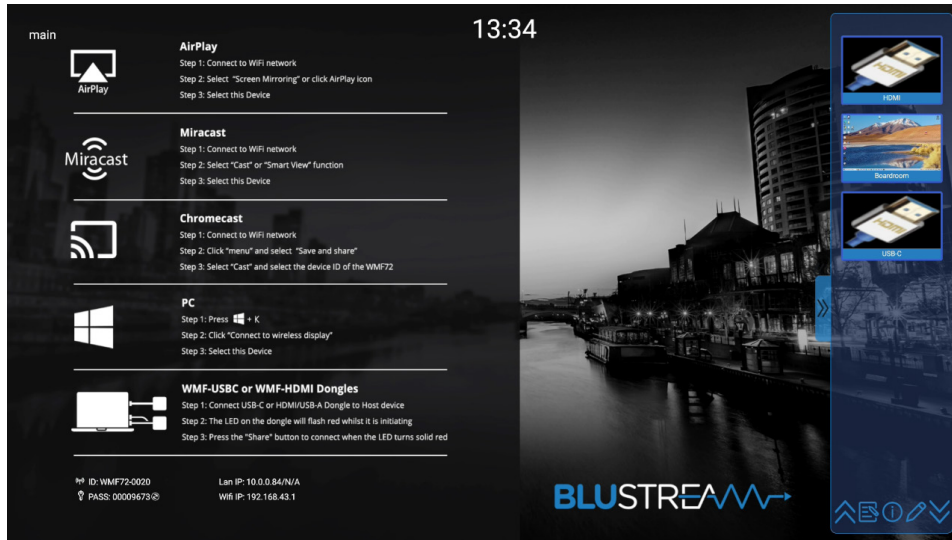

The following functions can be used by selecting the menu items at the bottom of the tab:



- 1 Scroll up: scrolls up through the available wireless device thumbnails shown inside the pop-out menu
- 2 Whiteboard: allows for the user of an interactive display to have a blank screen for drawing / notes
- 3 Information: enables or disables the onscreen display information pop up
- 4 Annotation: allows the user of an interactive display to annotate over the top of the shared content
- 5 Scroll down: scrolls down through the available wireless device thumbnails shown inside the pop-out menu

Each connected device will be shown in the side menu. Wirelessly connected devices paired with the WMF72 will preview the input device (previews are not available for some wireless connections; i.e., Airplay). The user can select any connected device on this menu and configure the following control options :



- The left hand button shows the connectivity status of the wireless device.
  - A 'Stop / square' symbol (shown in the adjacent figure), indicates that the device is connected and is currently sharing to WMF72. Pressing the 'Stop / square' button stops sharing.
  - A 'Play' symbol (shown in the adjacent figure) indicates that the device is connected but inactive and not sharing to the WMF72. Pressing the 'Play' button will start sharing the device.
- The centre button denotes whether the input is part of a multiview configuration or being shown in full screen.
- The right hand button gives the user the ability to mute or unmut the input.



The pop-out tab can be re-positioned by dragging the tab up or down as required.

If an interactive panel is not being used, the tab and sidebar disabled via the web-GUI or via API commands.

**Whiteboard:**

Selecting the whiteboard button on the sidebar will bring up a blank canvas that allows touch input to be drawn to an interactive screen, and for the image to be saved and shared. Additional toolbars can be accessed as described below:

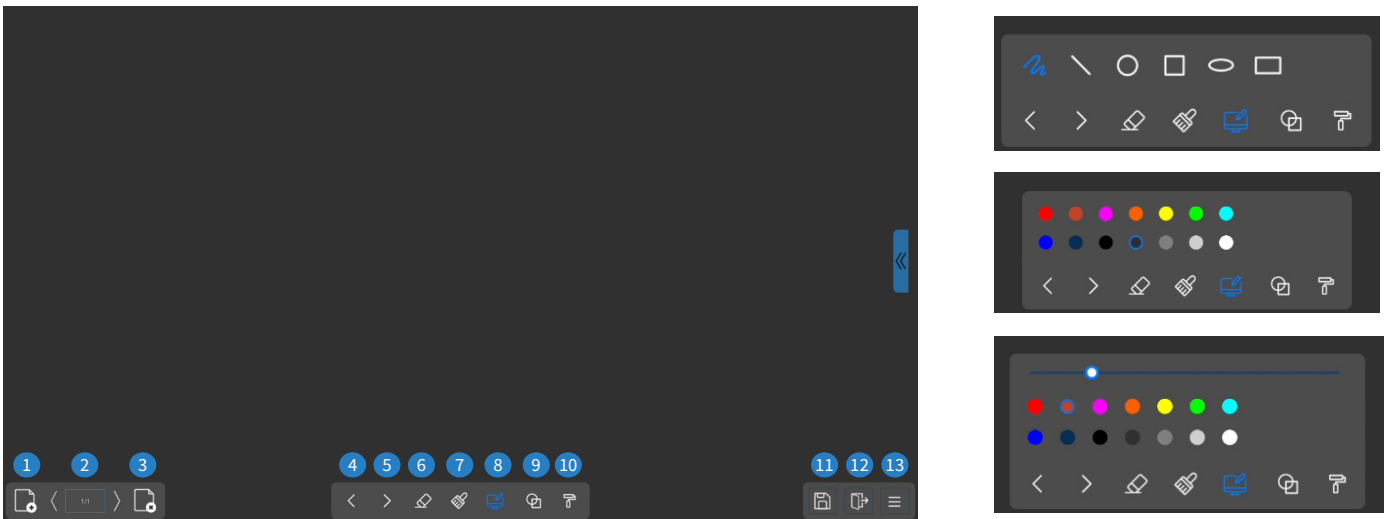

The following functions can be operated by pressing the corresponding button:

- 1 New page: creates a new blank page
- 2 Page navigation: scroll through the available pages using the arrows
- 3 Delete page: delete the current page
- 4 Undo: undo the previous action
- 5 Redo: redo the previous action
- 6 Eraser: touch input on the display acts as an eraser
- 7 Clear all: clears all input from the canvas
- 8 Pen: touch input on the display acts as a pen; colour and size can be modified by pressing this button again
- 9 Shapes: sets touch input to draw shapes; the shape and the colour can be modified by pressing this button again
- 10 Canvas colour: sets the canvas to a selected colour
- 11 Save: opens the save dialog
- 12 Exit: returns to the previous input/multiview layout (save confirmation will display)
- 13 Menu: opens the Whiteboard menu for additional settings

Pressing the menu icon will open a sub menu with additional options:

- Open                      open a saved project
- New project              exit the current project and create a new project
- Save as                    save the current project
- Import from USB disk    import a project from a USB
- Save as Udisk            save a project to a USB
- Save as PDF              save the project as a PDF file
- Clear history             clear the saved projects on the internal storage

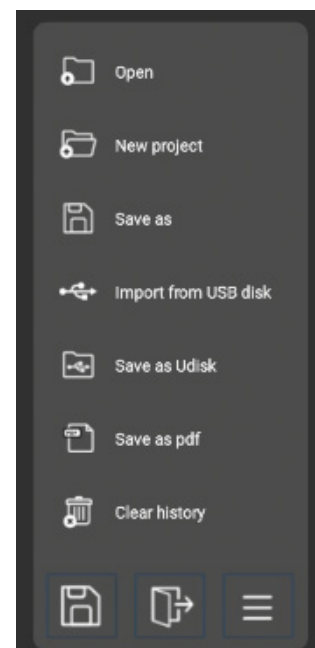

Whiteboard (continued)

Once you are finished editing, the canvas is able to be saved to an image by pressing any of the save options; allowing it to be downloaded to a flash drive inserted into a USB 3.0 port, or to the internal memory of the WMF72.

It can then be shared over the network via a QR code.

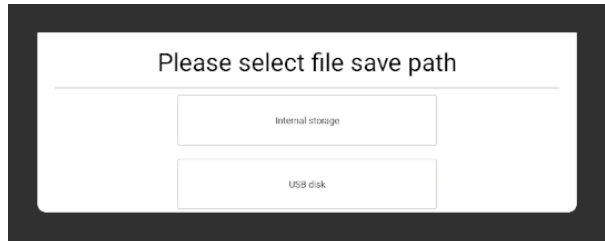

Enter the file name using the onscreen keyboard.

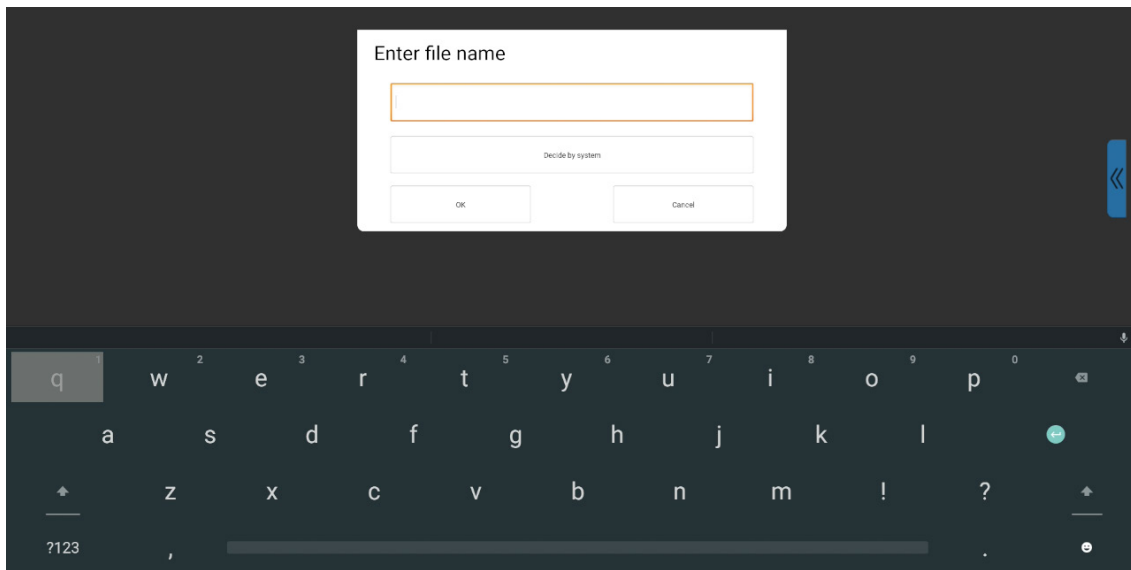

Once the file is saved, it can be access via the LAN or Wi-Fi network using a QR code.

**Please note:** the QR code/s displayed will depend on the selected network mode.

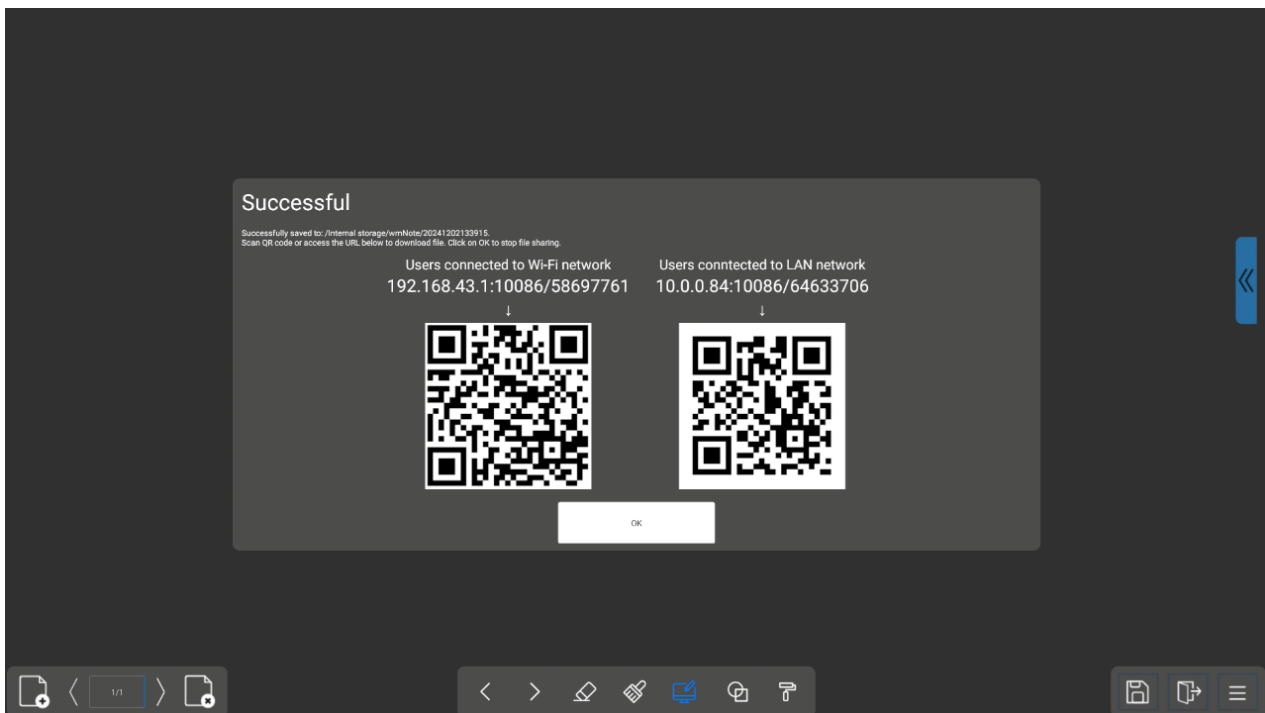

**Annotation:**

Selecting the annotation button on the sidebar will provide markup tools, that can be operated through touch input, to be drawn to an interactive screen, and for the image to be saved and shared.

This markup will display over the output even if the input or multiview layout is changed. This image can then be saved and shared. Additional toolbars can be accessed as described below:

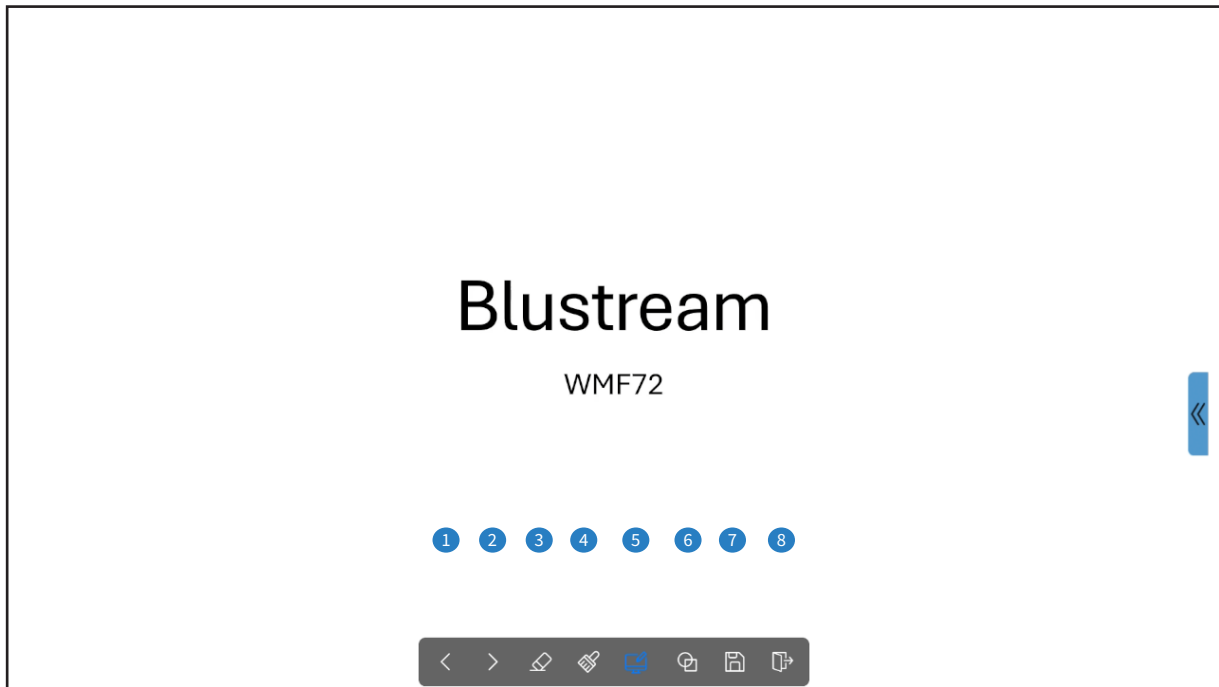

The following functions can be operated by pressing the corresponding button:

- ① Undo: undo the previous action
- ② Redo: redo the previous action
- ③ Eraser: touch input on the display acts as an eraser
- ④ Clear all: clears all input from the canvas
- ⑤ Pen: touch input on the display acts as a pen; colour and size can be modified by pressing this button again
- ⑥ Shapes: sets touch input to draw shapes; the shape and the colour can be modified by pressing this button again
- ⑦ Save: opens the save dialog
- ⑧ Exit: returns to the previous input/multiview layout (save confirmation will display)

Once you are finished editing, the markup and current display is able to be saved to an image by pressing any of the save options; allowing it to be downloaded to a flash drive inserted into a USB 3.0 port, or to the internal memory of the WMF72.

It can then be shared over the network via a QR code.

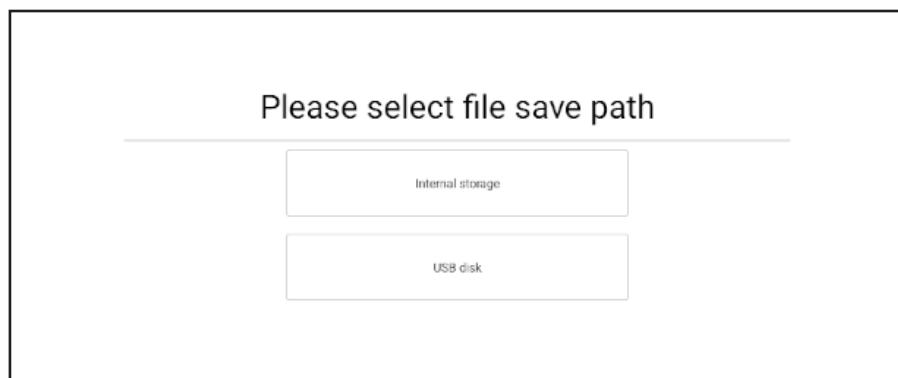

**Annotation (continued)**

Enter the file name using the on screen keyboard.

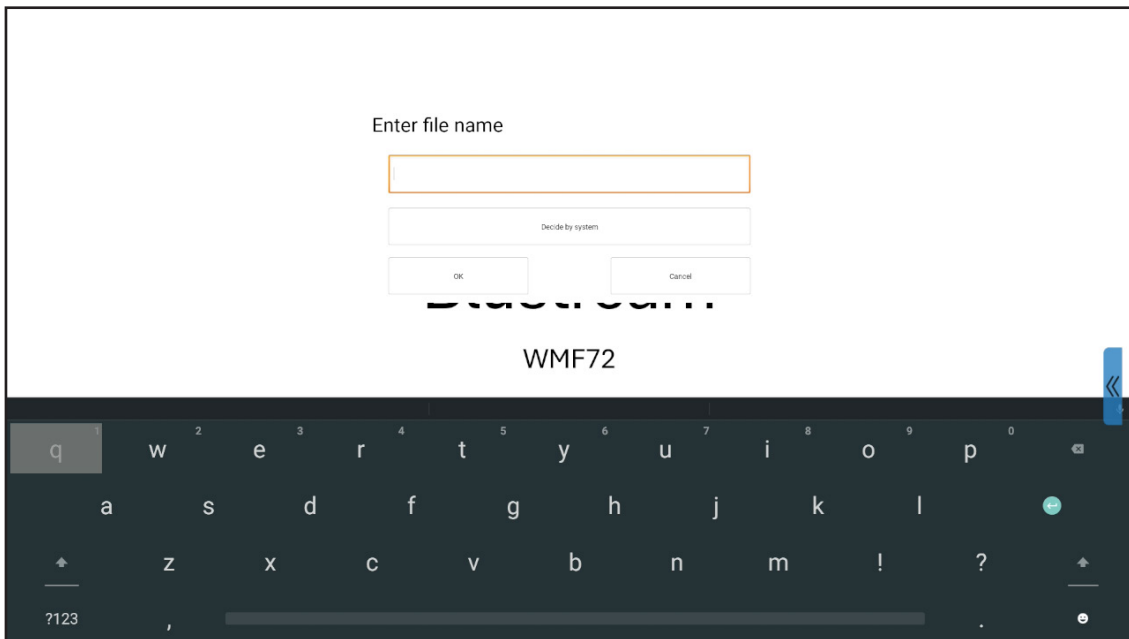

Once the file is saved, it can be access via the LAN or Wi-Fi network using a QR code.

**Please note:** the QR code/s displayed will depend on the selected network mode.



# Dual HDMI Output Connectivity

The WMF72 allows for dual display connectivity via the HDMI Main and HDMI Sub out. Multiview is supported with dual outputs and can be configured in one of three ways:

## Mirroring output mode

In mirroring output mode, both the main and sub display will output the same image (multiview supported).

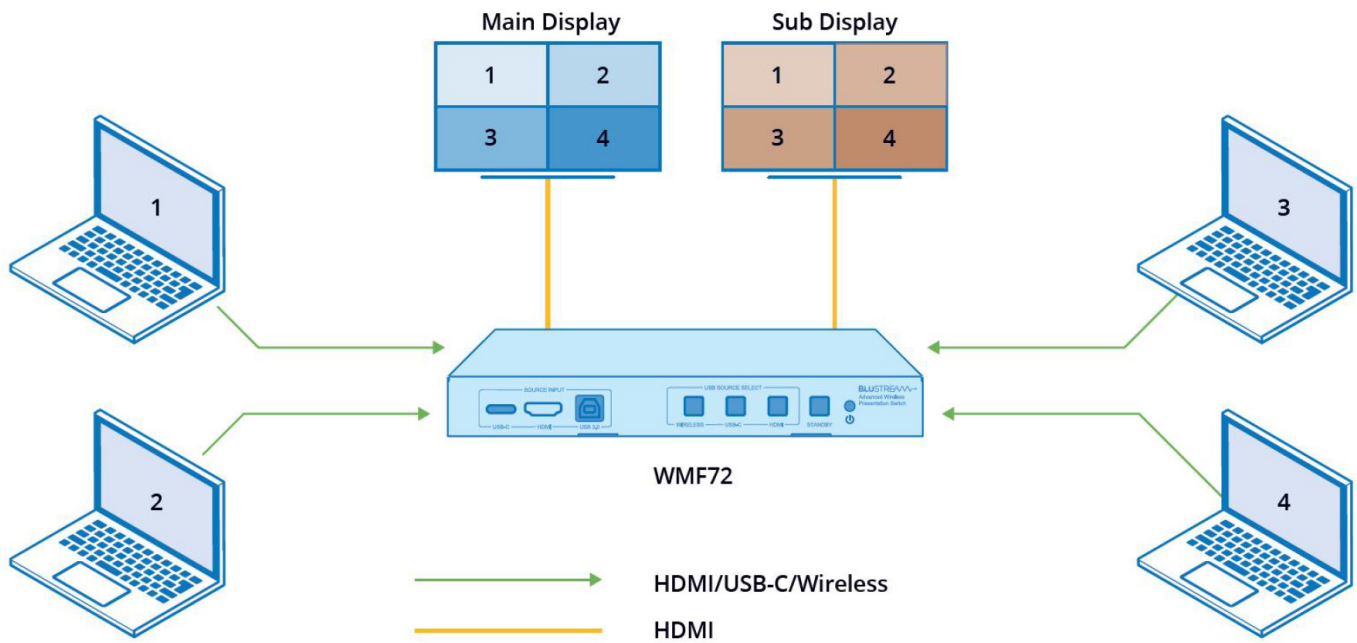

## Multiview and single view mode

In Multiview and single view mode, the main display will support multiview and the sub display will support single view

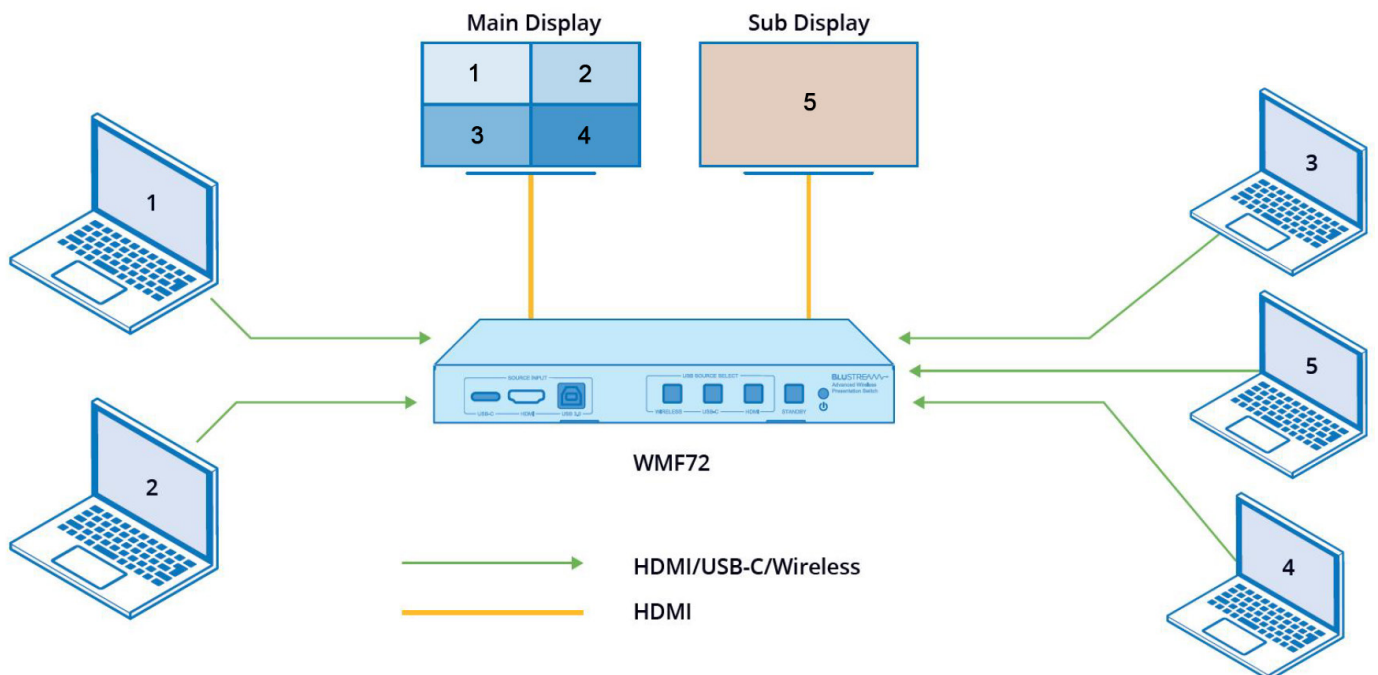

### Single and multiview mode

In single and multiview mode the main display will support single view and the sub display will support multiview

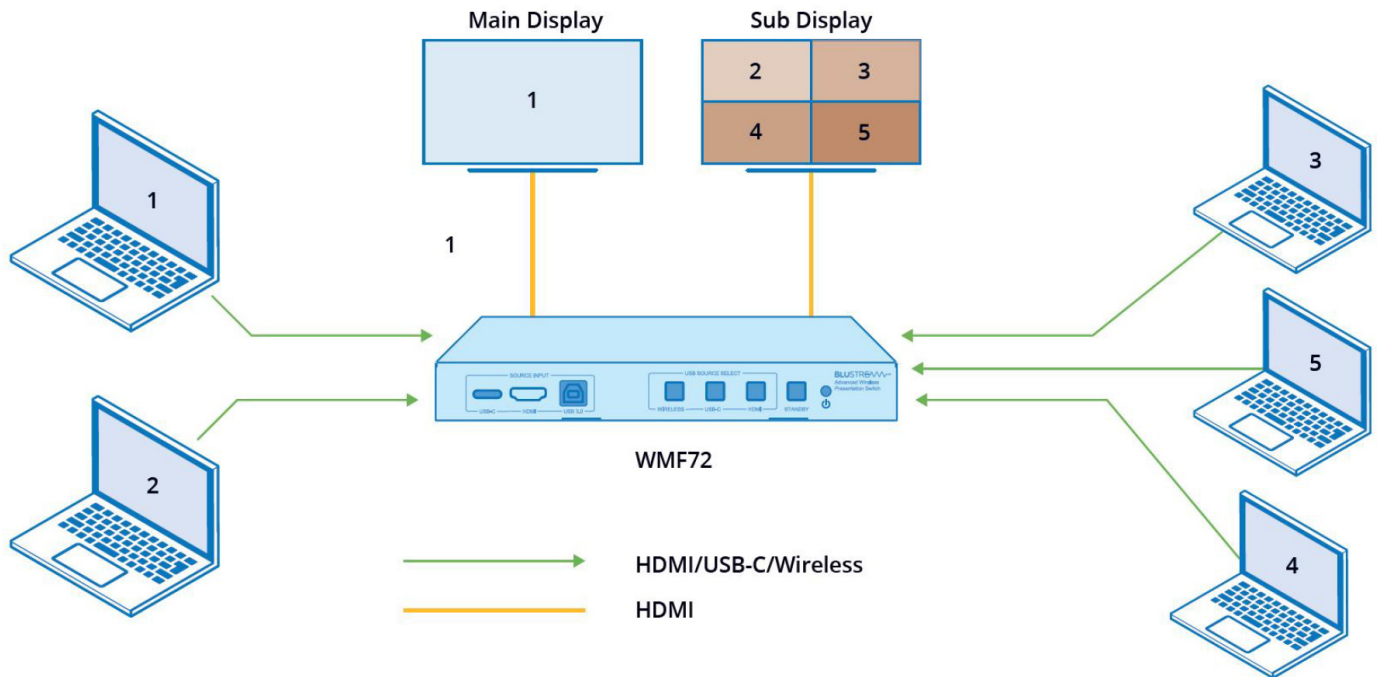

## USB 3.0 Hub & USB Sharing

The WMF72 has the ability to share up to three USB devices to connected host devices. These can be shared either via a wired connection to the ports on the front panel, or wirelessly via the Blustream WMF control app (see page 10 for installation and configuration of the Blustream WMF Control app.)

**Please note:** Wireless connections are only able to share 1 x camera, 1 x microphone and 1 x speaker (e.g., if there are two cameras connected, the WMF72 will only recognise the first connected camera).

An all-in-one unit (webcam/microphone/speaker) is recommended for best functionality.

**WARNING:** When using separate devices for microphone and speaker, a dedicated DSP is recommended for echo cancellation and feedback elimination.

Manual host switching can be achieved by using the 'USB Source Select' button on the front of the unit, through the web-GUI or via API commands. The USB host can also be automatically switched upon connection of a new host. This logic can be set in the web-GUI.

To share a USB device, connect it to one of the three USB 3.0 ports on the rear of the unit.

For wired hosts (USB-C and USB-B), the USB device will pass-through to the host as if it was connected directly.

For wireless hosts, the Blustream WMF Control app will need to be utilised. It can be installed from the App page on the web-GUI, from the product page on the Blustream website, or installed from a connected dongle.

With the app installed and running, set the host's Wi-Fi to the WMF72's SSID, or select an SSID which is in the same LAN as the WMF72 (depending on network mode).

**Please note:** When using the dongle, the Wi-Fi information stored during pairing, will be copied into the host's Wi-Fi settings.



### USB 3.0 Hub & USB Sharing (continued)

With the app connected to the WMF72, ensure USB Select is set to Wireless.

The camera icon in the bottom right corner will turn green once device is sharing.

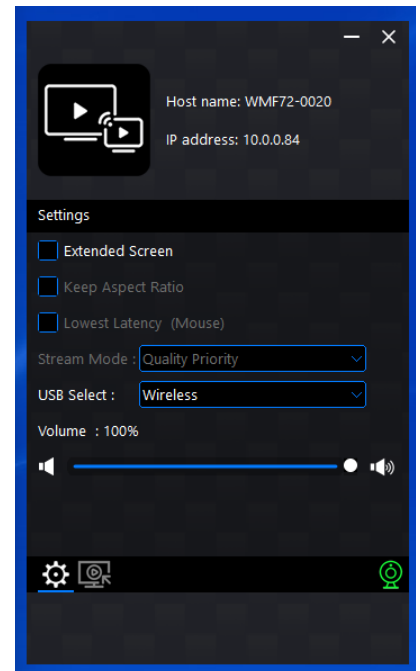

The wireless input will appear as Virtual Meeting Camera.

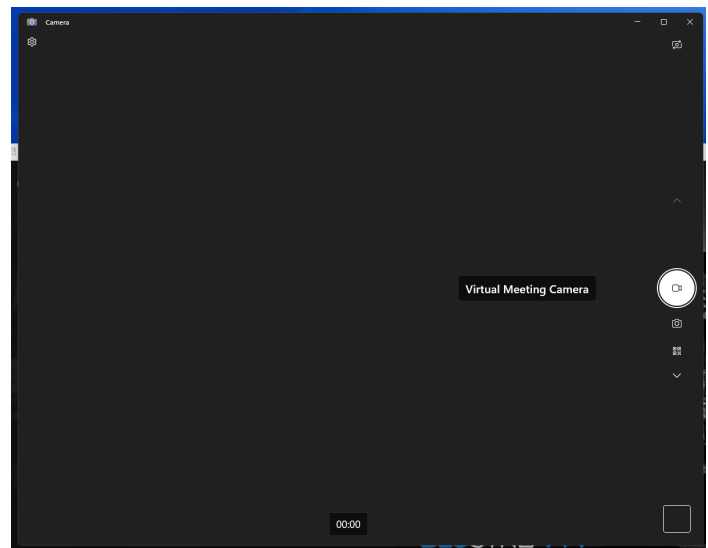

Switch to the 'Virtual Meeting Camera' input in the desired application and the input will be shared wirelessly from the WMF72.

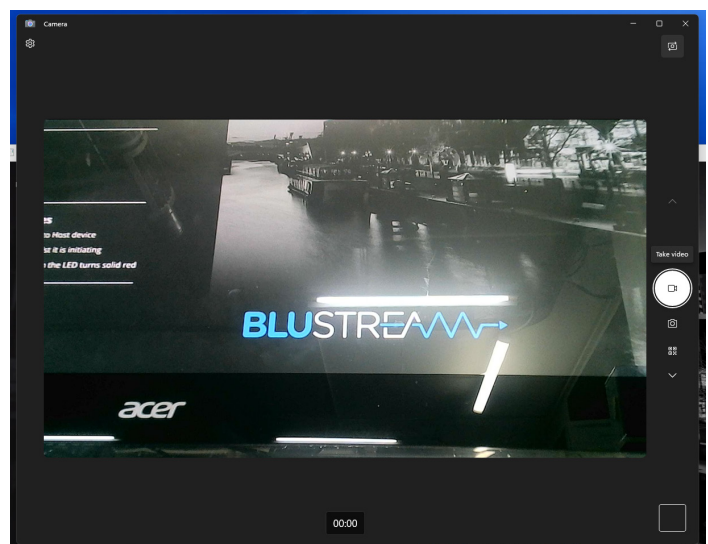



# Network Connectivity Options

The WMF72 has multiple different ways in which it can be deployed into a system with regards to its connectivity to multiple networks, whether it is used as standalone device, or a combination of all.

## LAN Access Point Mode:

LAN connection to the Corporate network. WMF72 hosts its own Wi-Fi network not associated with Corporate LAN for dongle communication.

### LAN Access Point Mode

Hardwired LAN1 or LAN2 connected to a single Third Party Network

Mode: **Access Point Mode**

*In access point mode all sources can be connected directly to the built-in WiFi. Third party casting methods can also be shared via LAN connection.*

*Built-in WiFi settings are configurable via web GUI.*

*Internet access via LAN can be enabled/disabled.*

**Sample Application:**

- Device ID: WMF72-8042
- Pass: 00001185
- LAN IP: 169.254.2.51/N/A
- Wifi IP: 192.168.43.1

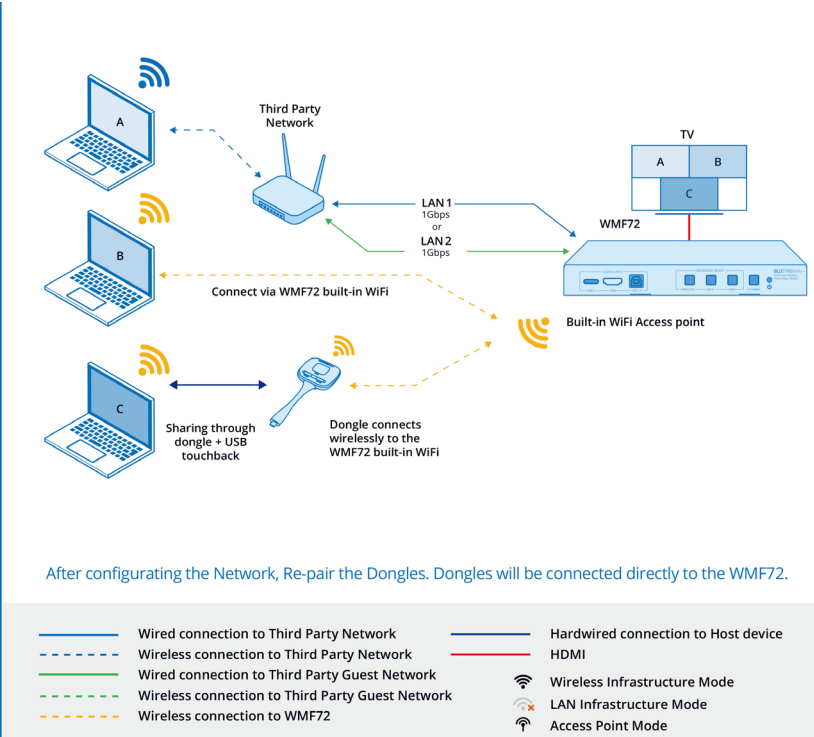

## Dual Network Configuration with Access Point:

Dual Corporate and Guest LAN connectivity where the WMF72 hosts its own Wi-Fi access point not associated with the Corporate or Guest LAN's.

### DUAL Network Configuration Access Point Mode

Hardwired LAN1 and LAN2 connected to Third Party Networks

Mode: **Access Point Mode**

*In access point mode all sources can be connected directly to the built-in WiFi. Third party casting methods can also be shared via LAN connection.*

*Built-in WiFi settings are configurable via web GUI.*

*Internet access via LAN can be enabled/disabled.*

**Sample Application:**

- Device ID: WMF72-8042
- Pass: 00001185
- LAN IP: 169.254.2.51/169.254.59.124
- Wifi IP: 192.168.43.1

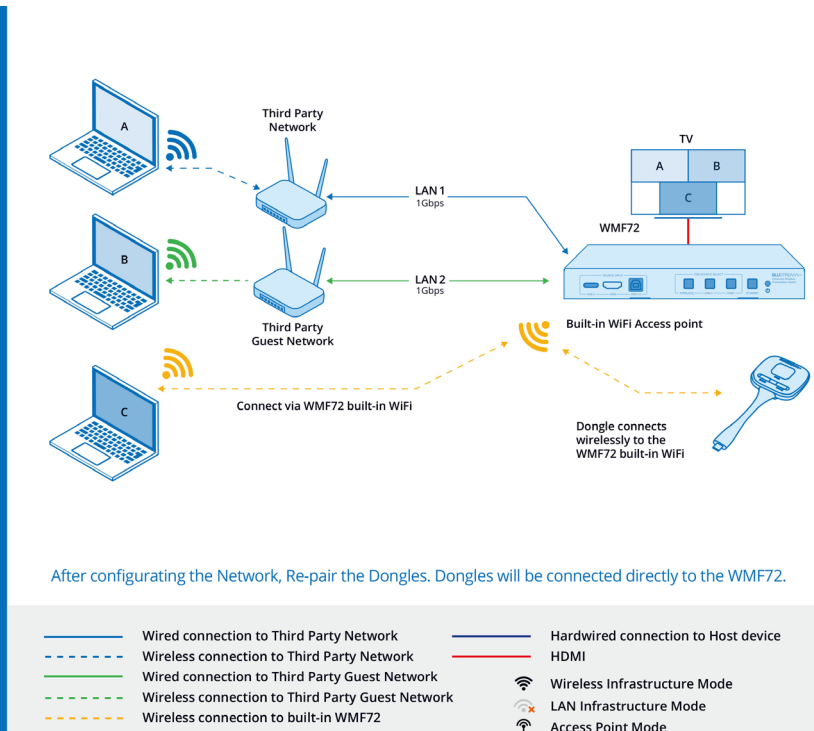

Wireless Infrastructure Mode

Communication with the WMF72 is via the corporate Wireless network only.

### Wireless Infrastructure Mode

WMF72 is wirelessly connected to third party WiFi. Built-in WiFi of the WMF72 is disabled.

Mode: **Wireless Infrastructure Mode**

*In wireless infrastructure mode, the dongles connect to the WMF72 via third party WiFi network. The WMF72 is connected wirelessly to the third party network.*

*Third party network details are entered into WMF72 via web GUI and transferred to the dongles during pairing process.*

**Sample Application:**

- Device ID: WMF72-8042
- Pass: 00001185
- LAN IP: N/A/169.254.59.124
- Wifi IP: 169.254.162.14

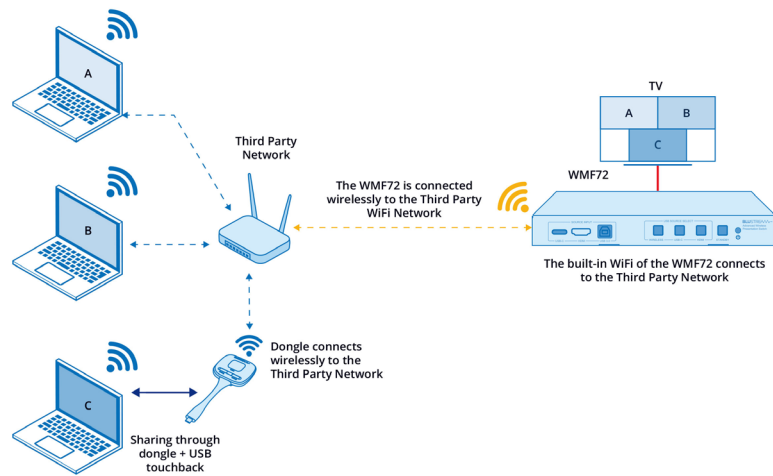

After configuring the Network, Re-pair the Dongles. Dongles will be connected directly to the Guest network.

Wireless Infrastructure Mode:

LAN1/2 connection to the Corporate LAN. Dongles communicate through the Corporate LAN to the WMF72. Wi-Fi on the WMF72 linked to a third party Guest network.

### Wireless Infrastructure Mode

WMF72 is hardwired to the Third Party Network and wirelessly connected to Third Party Guest Network

Mode: **Wireless Infrastructure Mode**

*In wireless infrastructure mode, the dongles connect to the WMF72 via third party WiFi network. The WMF72 is connected wirelessly to the third party network.*

*Third party network details are entered into WMF72 via web GUI and transferred to the dongles during pairing process.*

**Sample Application:**

- Device ID: WMF72-8042
- Pass: 00001185
- LAN IP: N/A/169.254.59.124
- Wifi IP: 169.254.162.14

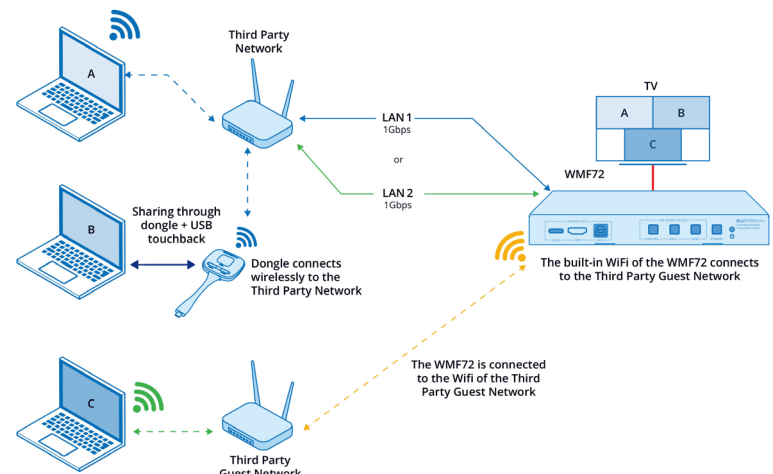

After configuring the Network, Re-pair the Dongles. Dongles will be connected directly to the Guest network.

LAN Infrastructure Mode (in-built Wireless network disabled)

LAN and dongle connection to the Corporate LAN only. WMF72 does not host its own Wi-Fi network.

### LAN Infrastructure Mode

WMF72 is hardwired to existing LAN. Built-in WiFi of the WMF72 is disabled

Mode LAN Infrastructure Mode

*In LAN infrastructure mode, the dongles connect to the WMF72 via third party WiFi network. The WMF72 is connected via hardwired LAN to the third party network.*

*Third party network details are entered into WMF72 via web GUI and transferred to the dongles during pairing process.*

**Sample Application:**

- 📶 Device ID: WMF72-8042
- 🔑 Pass: 00001185
- 🌐 LAN IP: N/A/169.254.59.124
- 📶 Wifi IP: 192.168.43.1

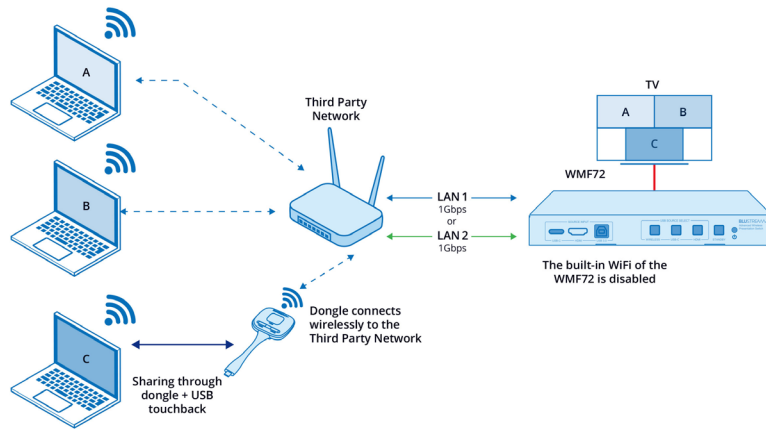

After configuring the Network, Re-pair the Dongles. Dongles will be connected directly to the LAN 1 network.

	Wired connection to Third Party Network		Hardwired connection to Host device HDMI
	Wireless connection to Third Party Network		Wireless Infrastructure Mode
	Wired connection to Third Party Network		LAN Infrastructure Mode
	Wireless connection to Third Party Network		Access Point Mode
	Wireless connection to WMF72		

**Network Connectivity Options (continued)**

While in Access Point mode, internet access can be bridged via the LAN 1/2 port.

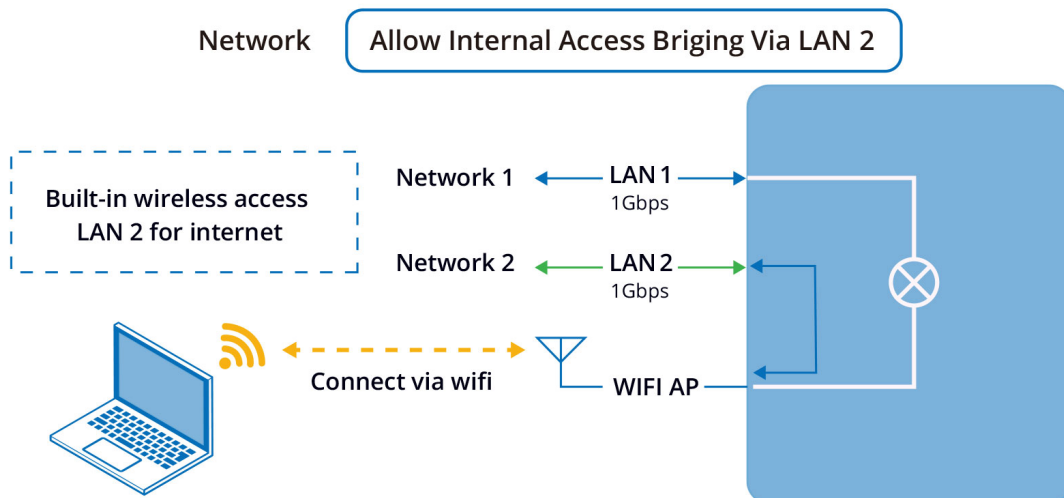
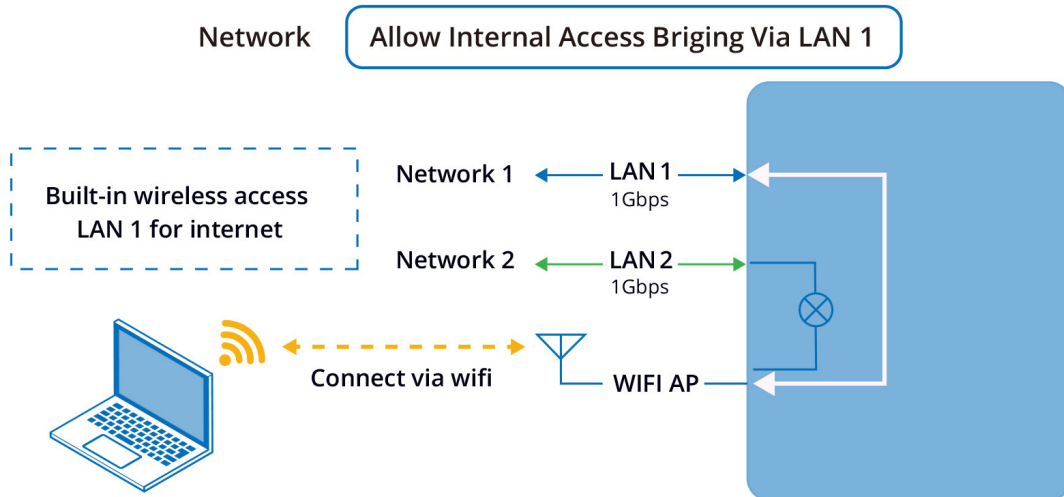
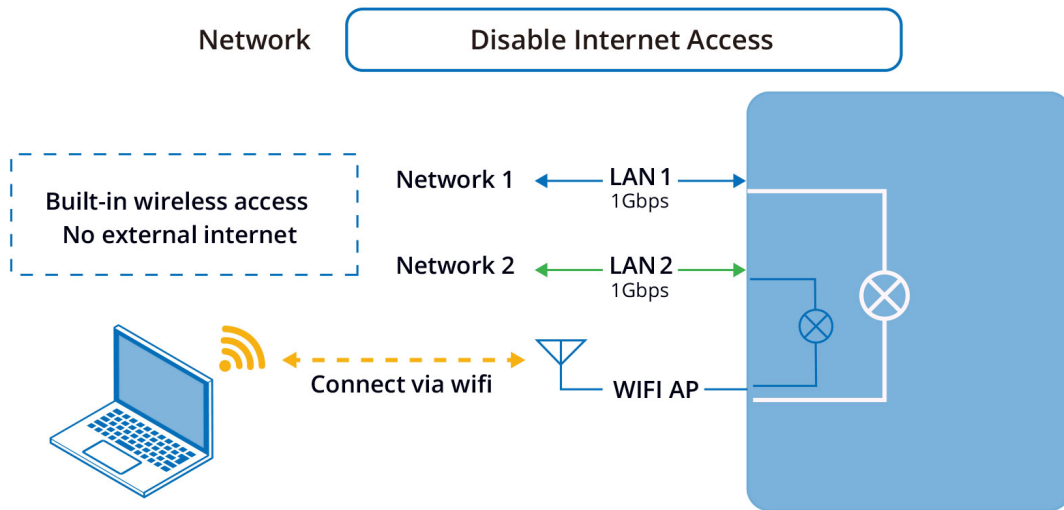

- Wired connection to LAN 1 Network
- - - Wireless connection to LAN 1 Network
- Wired connection to LAN 2 Network
- - - Wireless connection to LAN 2 Network
- - - Wireless connection to WMF72

# Network Configuration

The WMF72 features an in-built web-GUI which is required for advanced control and configuration of the device. This includes features such as source / input management, output scaler resolution, network / Wi-Fi configuration, and user control.

You can connect to the WMF72 either via hard wired LAN connection, or via the built-in Wi-Fi.

**Please note:** It is recommended to use LAN 2 when hard wiring directly to the WMF72 from a PC for configuration.

If the WMF72 is connected to a pre-existing network then it will be provided an IP Address via DHCP. There are several ways in which you can find the IP address of the device as follows:

- The On Screen Display shows the IP address of the product in the lower left corner of the screen (item A in the image below) labelled: 'LAN IP: xxx.xxx.xxx.xxx / yyy.yyy.yyy.yyy' (where xxx = IP address of LAN port 1, and yyy = IP address of LAN port 2). Where no hard wired connections are available, the screen will show N/A for either of the 2 x possible connections.
- Use a 3rd party IP scanning tool on your PC to find the IP address of the WMF72.

## Connecting via the LAN 1 port:

By default, this port is set to DHCP. If connected to a DHCP server, the IP address will be issued by the network / router.

## Connecting via the LAN 2 port:

By default this port is set to DHCP. If connected to a DHCP server, the IP address will be issued by the network / router, however if a DHCP server is not installed or you connect directly from a PC to the WMF72, the IP address will revert to the below details:

Default **IP Address:** 192.168.0.200

## Connecting via Wi-Fi:

This device can broadcast its own local Wi-Fi access point which users can connect to in order to stream content to the device, or control and configure the unit. The default local Wi-Fi access point settings are as follows:

Default **Device ID / SSID** is: WMF72-xxxx (where xxxx is bound to MAC address of the unit)

Default **SSID Password** is set to dynamic by default and displayed on screen

Default **BYOD PIN** is an 8 digit code displayed on screen that by default automatically changes every 5 minutes

It is also possible to disable the local Wi-Fi access point and hard wire the WMF72 into a pre-existing data network. You would then use the pre-existing Wi-Fi access points to connect to the network and communicate with the WMF72.

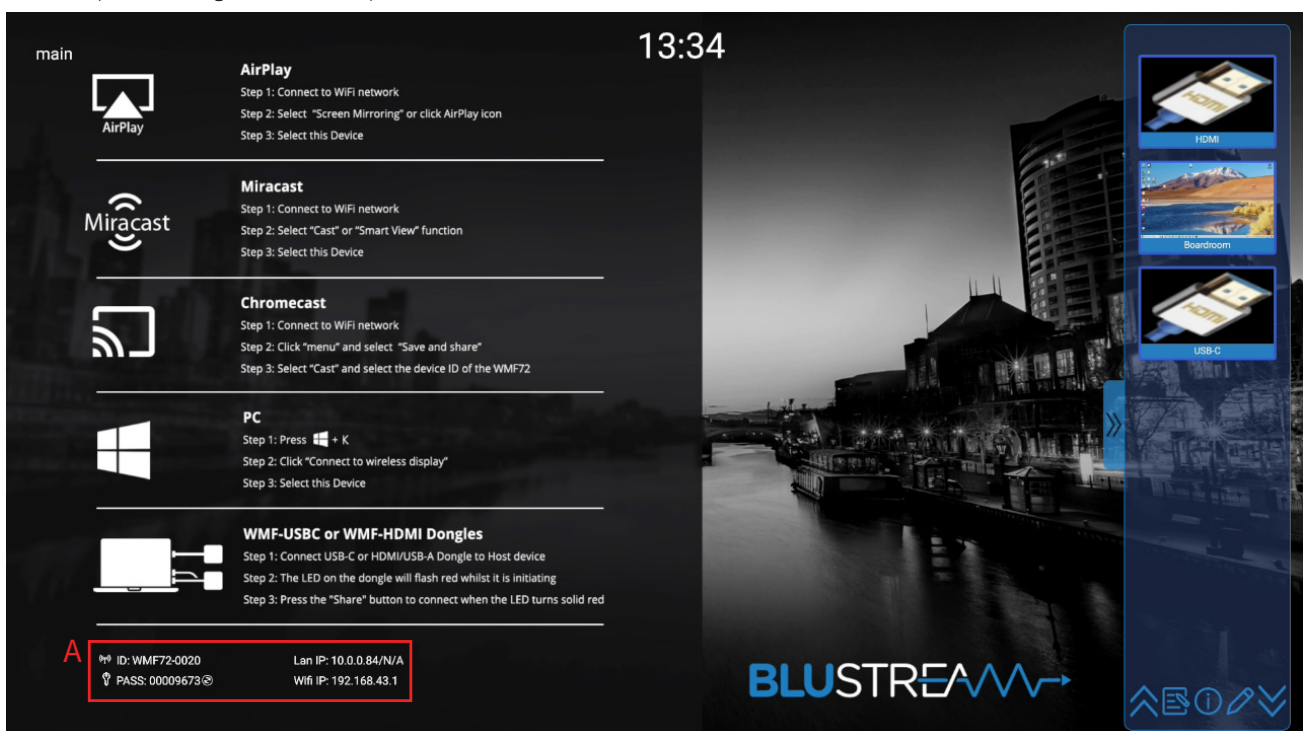

## Web-GUI - Log In and Initialisation

The following pages will take you through the operation of the WMF72 web-GUI. You must be connected to either the TCP/IP RJ45 socket to your local network, directly from your computer to the LAN 2 of the WMF72, or wirelessly to the unit in order to access the product's web-GUI.

By default, the unit is set to DHCP; however, if a DHCP server (eg: network router) is not installed, the unit's IP address will revert to below details:

Default IP Address is: [192.168.0.200](#)

Default Admin Username is: [blustream](#)

Default Admin Password is: [@BlS1234](#)

### Login Page:

When initially accessing the web-GUI of the WMF72, the Login Page is shown. Press the 'Login' button to select a user:

- Admin (Blustream) this account allows full access to all functions and configuration of the unit
- Guest this account allows for basic input switching only.

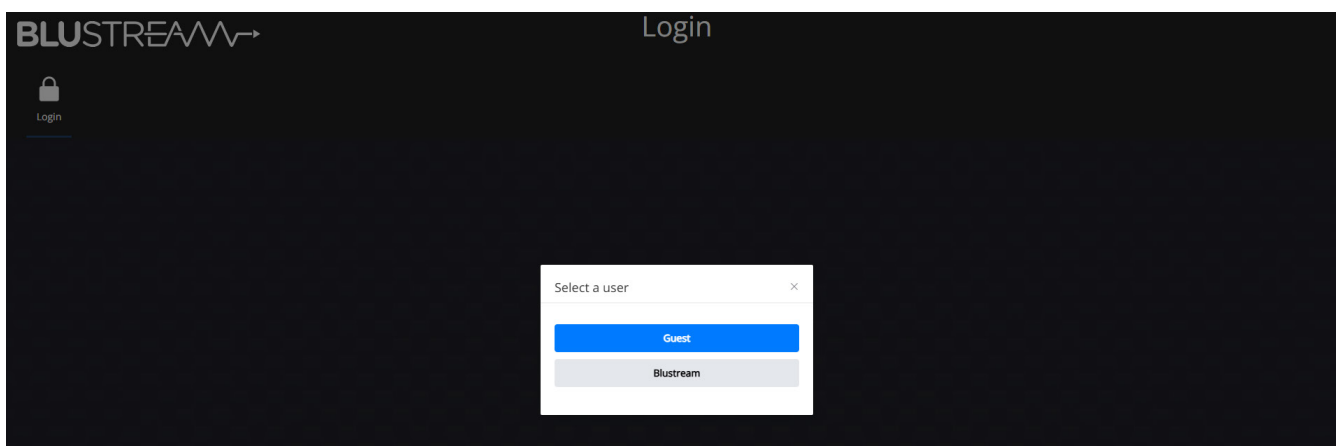

**Please note:** the first time the Administrator logs into the web-GUI of the WMF72, the default password must be changed to a unique password. Please retain this password for future use. Forgetting the password will mean having to factory reset the unit, losing all configuration settings.

Passwords can be changed as required within the web-GUI of the unit once logged in.

Current password	<input type="text" value="Enter current password"/>
New password	<input type="text" value="Enter new password"/>
Confirm new password	<input type="text" value="Enter new password"/>



# Web-GUI - Control

After logging in, the user will be shown the Control page. This page allows for any of the connected devices to be controlled and configured for the output of the device. By default, selection of single screen or multi-view layouts is automatic.

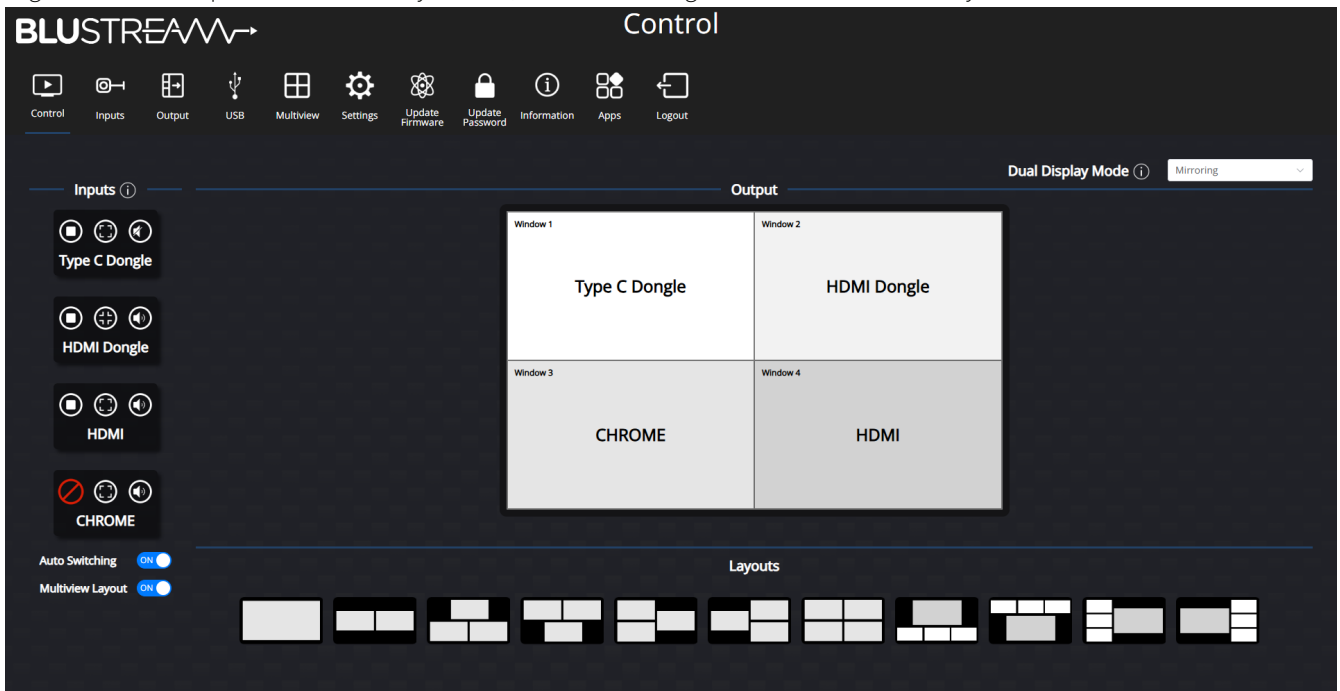

## Inputs:

When a new device is connected to the WMF72, it will appear under Inputs.

The following example in the below figures demonstrates the functionality when the **Audio mode** is set to the default of 'Audio mixer'.

Each device will have 3 actions which can be operated by clicking on the corresponding button (see image below).

**Please note:** Setting the the **Audio mode** to 'Single audio: Follow window', 'Single audio: First in' or 'Single audio: Last in' will disable the right hand button.

A mute button will be present on each window in the output render in 'Single audio: Follow window' mode (see image below). In 'Single audio: First in' or 'Single audio: Last in' mode, audio control logic will be applied depending on the mode set.

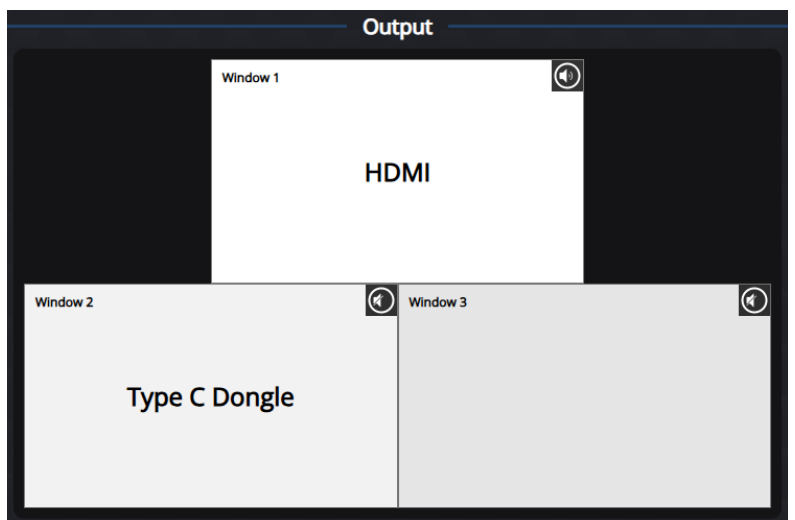
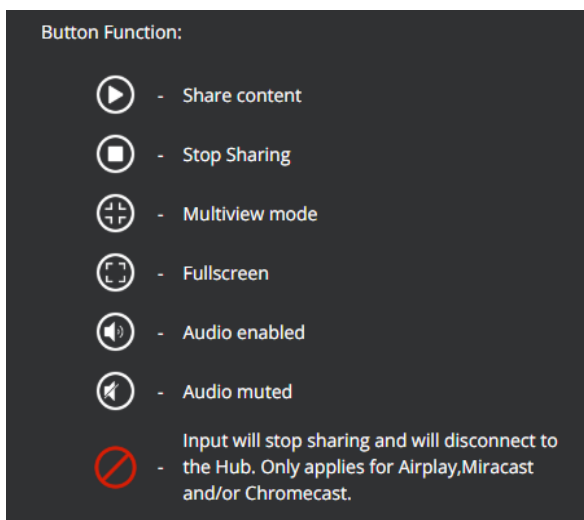



- The left hand button indicates whether a device is currently displaying:
  - A 'Stop / square' symbol, indicates that the device is connected and is currently sharing to WMF72. Pressing the 'Stop / square' button stops sharing, but the unit remains connected to the WMF72.
  - A 'Play' symbol indicates that the device is connected but inactive and not sharing to the WMF72. Pressing the 'Play' button will start sharing the device.
- Where a Miracast® Chromecast®, or Airplay device is connected, the ability to disconnect the device from the WMF72 is indicated with a red circle dissected with a line (shown in the adjacent figure). Pressing this button will disconnect the device, and it will disappear from the 'Inputs' list.
- The centre button denotes whether the input is set to multiview mode, or being shown in full screen. Pressing the centre button will swap between the input being displayed in a full screen format, and the currently configured multiview layout.
- The right hand button gives the user the ability to Mute the input's audio. On the example opposite, the HDMI Dongle's audio is being distributed. When the **Audio mode** is set to 'Single audio source', only one input's audio can be played. Pressing on a muted audio button will unmute that input and mute the input that was previously playing.

**Output:**

By default, the WMF72's Dual Display Mode is set to *Mirroring*. This can be changed with the drop down. *Mirroring* mode will display a single window for the Main & Sub output, with the position and label of each input. This allows up to 4 different streams to be output simultaneously. *'Multiview + Single view'* and *'Single view + Multiview'* mode will display separate windows for the Main and Sub outputs. This allows up to 5 different streams to be output simultaneously.

The window/s renders how the output will display. Inputs and positions can be controlled by dragging and dropping:

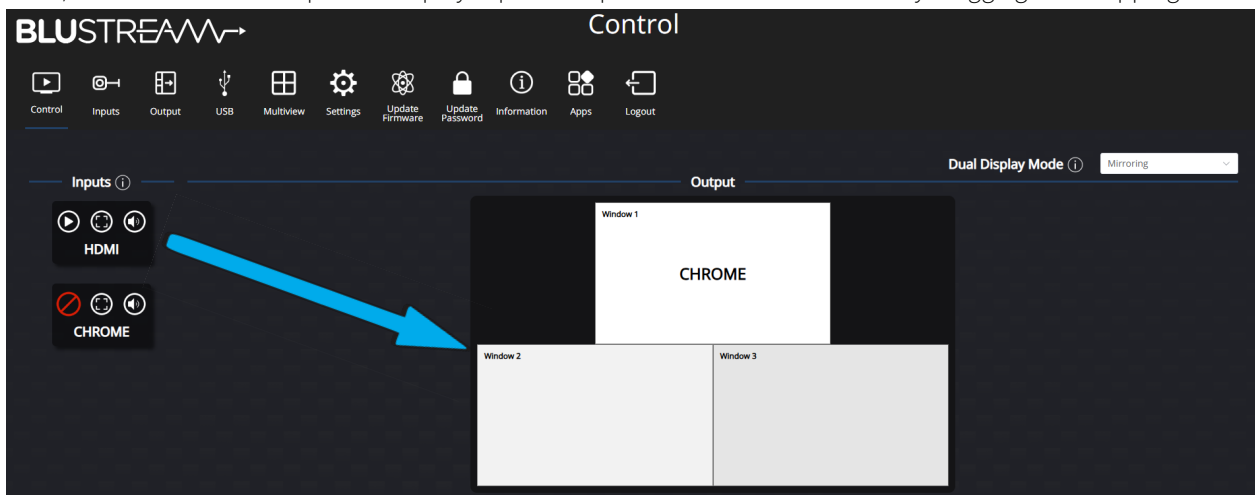

- Dragging an input not currently displaying to a blank window will set the input to start displaying in the current position.
- Dragging an input not currently displaying to where an input is already displaying will replace the current stream.
- Dragging an input that is currently displaying to a window with another input displaying will switch their window positions.

**Layouts:**

Auto Switching	automatically switch when a new input is detected
Multiview layout	enable / disable multiview layout control options

The selected multiview layout is highlighted in blue. The available multiview layouts, and their priority, can be configured in the Multiview page.



# Web-GUI - Inputs

The Inputs pages allows configuration of the connected devices, paired dongles and editing control permissions.

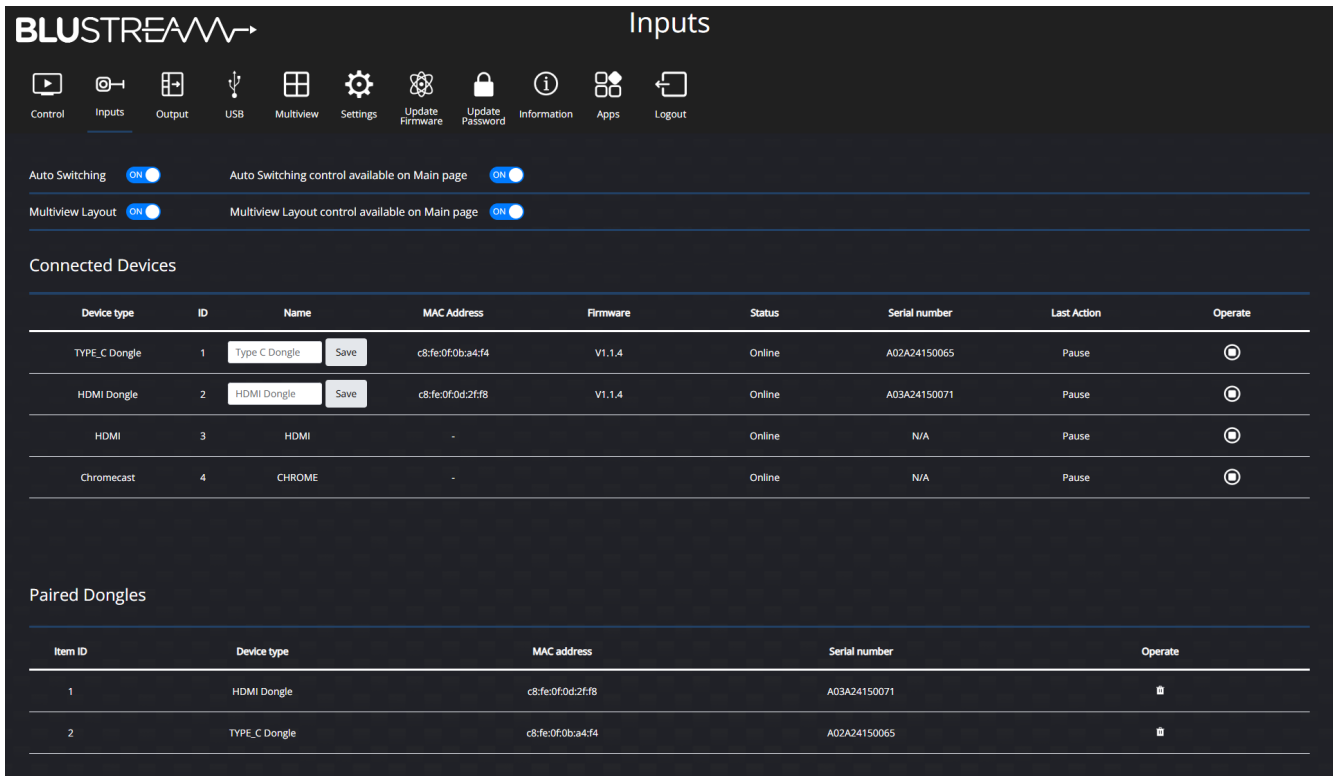

Auto switching and Multiview can be enable or disabled using the respective toggles.

In order to prevent the guest user from enabling or disabling Auto switching/Multiview, the respective toggles can be used to enable or disable the control from the Control page.

### Connected Devices:

Dongles, wired and wireless devices (Miracast®, Chromecast®, Airplay and App connections) that are connected to the WMF72 will be listed here, along with device information.

Devices can be renamed by entering a new name into the Name field and pressing Save. This change will reflect on the Control page to help organise and identify devices.

The device can be stopped/resumed from sharing, or disconnected, by toggling the *Operate* button.

### Paired Dongles:

Dongles that have been paired to the WMF72 are listed here, even if they are not currently connected. You can unpair them from the WMF72 by pressing the Operate button. If a dongle is removed, to use it with the unit again, it will need to be paired again by plugging it into the side of the unit.

# Web-GUI - Output

The Output pages allows for the user to manage settings relating to the audio and video output of the WMF72.

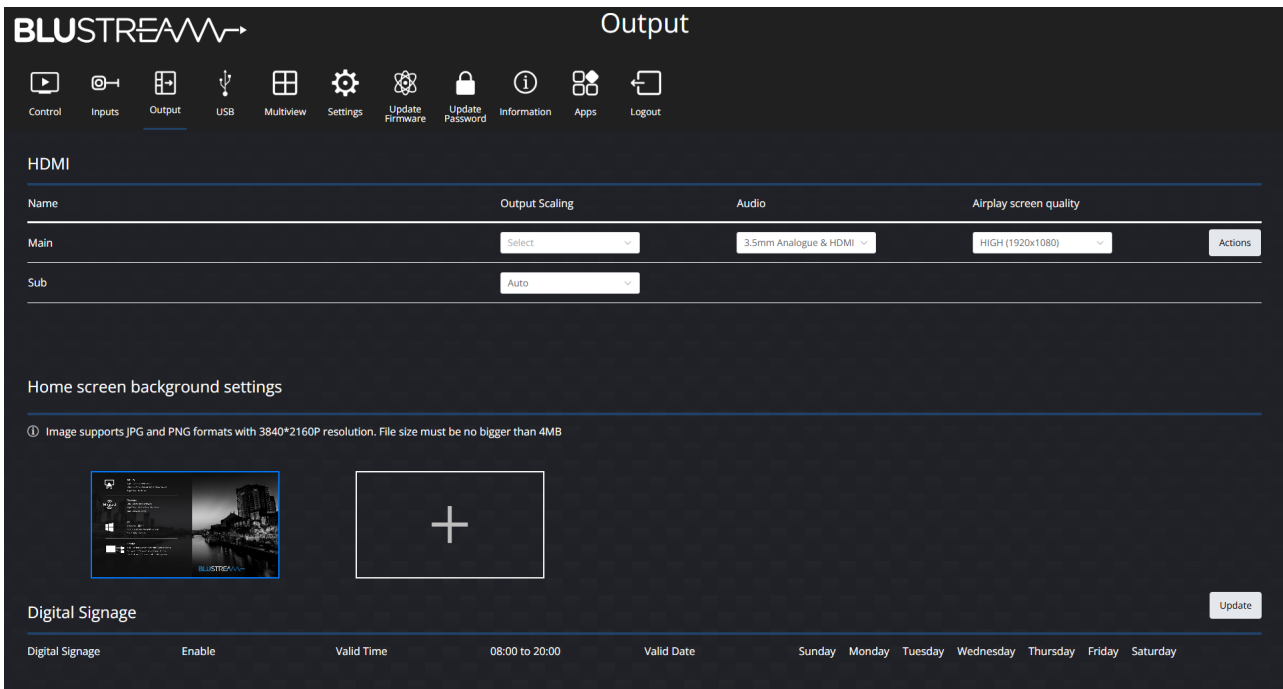

## HDMI:

To adjust the configuration for the HDMI Main and Sub outputs, select an option from the drop down menu:

- Output Scaling:
  - Set the resolution of the corresponding HDMI output. The default setting is Auto, which set an appropriate resolution based on the EDID of the display. The Main and Sub outputs can be scaled independently
- Audio:
  - Set the audio to output over HDMI, 3.5mm Analogue breakout, or both. This setting applies to the Main and Sub output.
- Airplay streaming resolution:
  - Set the resolution of Airplay streams being received. The default setting is High (1920x1080) for best image quality; however, adjusting this setting can improve performance in applications where wireless bandwidth may be reduced. This setting applies to the Main and Sub output.

The Actions button opens a sub menu for fine tuning the Output settings:

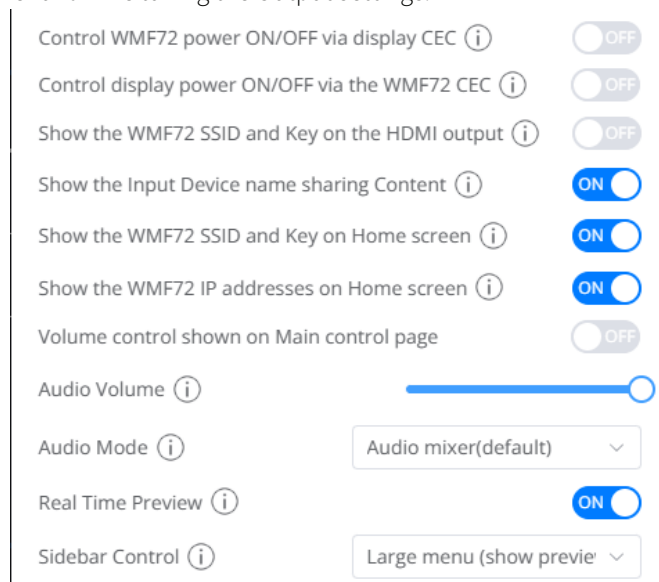

**HDMI (continued)**

- Control WMF72 power ON/OFF via display CEC:
  - Allows for a CEC power toggle command to be sent from the connected display to set the WMF72 to go in or out of standby when powering the display
- Control display power ON/OFF via the WMF72 CEC:
  - Allows for a CEC power toggle command to be sent from the WMF72 to set the display to go in or out of standby when powering the WMF72
- Show the Input Device name sharing content:
  - Show or hide the Input Device name sharing for 3 seconds
- Volume control shown on Main control page:
  - Allows for volume controls to be adjusted from the Control page
- Audio volume:
  - Adjust volume for both analogue audio and HDMI output
- Audio mode:
  - Allows selection of multiple or single audio outputs and how they are managed:
    - *Audio mixer (default)* Allows up to five input audio streams to play simultaneously on the output. Individual inputs can be muted using the interactive sidebar, the web-GUI or through API commands.
    - *Single audio source* Allows a single input audio stream to play on the output. The audio input can be selected the interactive sidebar, the web-GUI or through API commands. The currently playing input will be muted as soon as a new one is selected.
    - *Follow window* Allows a single input audio stream to play on the output. The audio output playing follows the selected multiview window which can be selected using the web-GUI drag and drop function, the API, or using the Mute function.
    - *First In* Allows a single audio stream to play on the output. The audio output follows the first input to share content to the WMF72. The second input to share content will take over if the first stops sharing or is disconnected, and so on. In this mode, manual audio selection will not be available.
    - *Last In* Allows a single audio stream to play on the output. The audio output follows the most recent input to share content to the WMF72. The second to last input to share content will take over if the most recent stops sharing or is disconnected, and so on. In this mode, manual audio selection will not be available.
- Real Time Preview:
  - Enable / disable the preview on the interactive sidebar. previews are not available for some wireless connections; i.e., Airplay, Chromecast, Miracast
- Sidebar Control:
  - Changes how the interactive sidebar will function:
 

Hide side bar completely	Disables the sidebar from opening
Small menu	Sidebar will open but without the preview windows
Large menu	Sidebar will open with a preview of the input

**Home screen background setting:**

Allows you to upload and select a custom background image, or use the default WMF72 home screen. The home screen displays via the HDMI Main and Sub output when there are no devices currently outputting. The home screen by default provides all the necessary information to connect a device to the WMF72

To upload a custom home screen simply press the '+' box and select the image file from your PC.

To delete a custom home screen, hover over the home screen image and select the bin icon in the top right corner of the image. A maximum of 4 home screens can be loaded onto the unit at once.

The home screen image must meet the following requirements:

- File type: .jpg or .png
- Resolution: 3840 x 2160 pixels
- Maximum file size: 4Mb

**Digital Signage:**

During auto stand-by, the WMF72 can be configured to display a web page on the HDMI output by using Digital Signage.

**Please note:** Auto standby must be turned on under **General Settings** on the **Settings** page.

### Digital Signage

Digital Signage

Note: The digital signage function is activated after the time period configured in the menu item "Auto stand-by" has elapsed.

Url

Set time range  To

Minimize network status bar on homescreen

Only on these days:

Sunday  Monday  Tuesday

Wednesday  Thursday  Friday

Saturday

Enter the URL of the website you would like to display, and set between which times and on what day you would like the Digital Signage to be displayed.

## Web-GUI - USB

The WMF72 is able to share USB devices through wired USB-C and USB-B hosts, as well as wirelessly through devices that have the Blustream WMF control app installed.

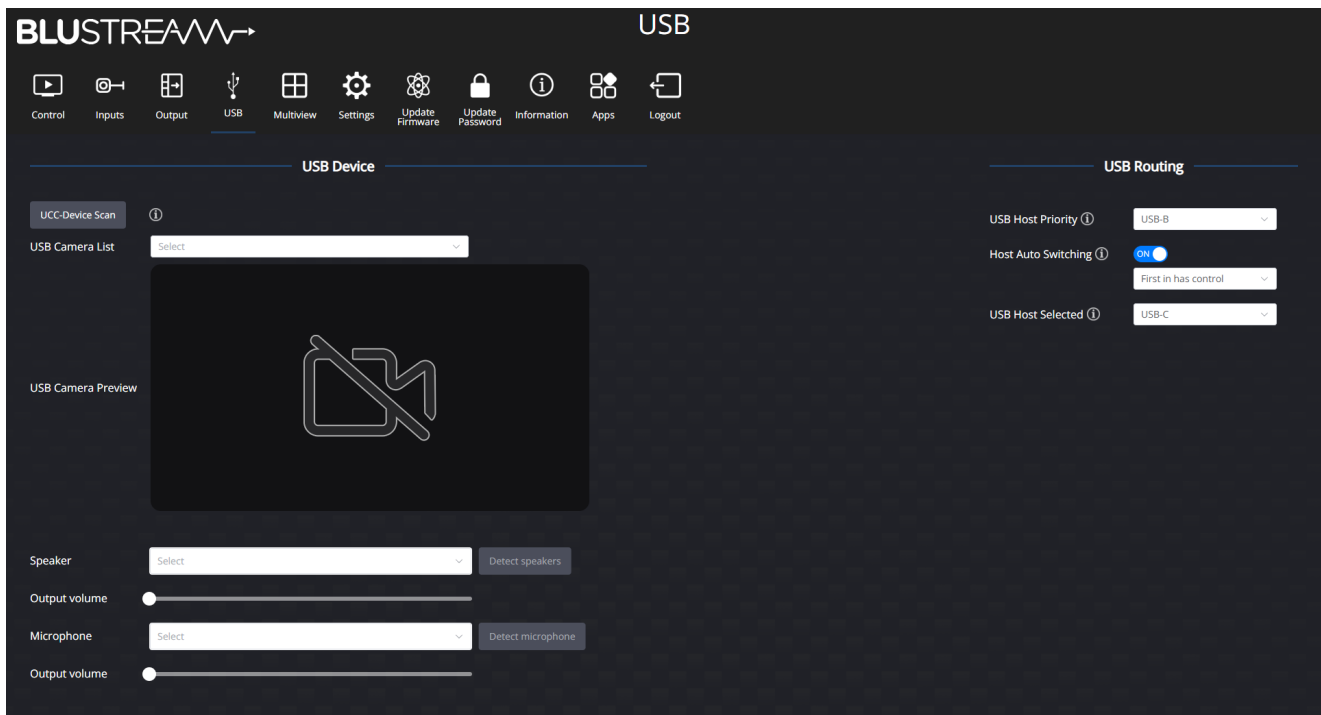

### USB Device

The wireless USB sharing functionality can be tested and configured in this section.

To test if the wireless USB device sharing is functioning, press the *UCC-Device Scan* button. The USB host will switch to Wireless and the below fields will populate with the USB devices.

#### USB Camera List

- Select the device from the *USB Camera List* drop down menu that will be shared wirelessly.
- To test if the USB camera device is being shared, check the *USB Camera Preview* below. If a wireless host begins controlling the USB camera, the preview will be disabled.

#### Speaker

- Select the device from the *Speaker* drop down menu that will be shared wirelessly.
- To test if the USB speaker device is being shared, press the *Detect speaker* button. A test audio will play on the output of the audio out set in the Output page
- The output volume can be set with the *Output volume* slider

#### Microphone

- Select the device from the *Microphone* drop down menu that will be shared wirelessly.
- To test if the USB microphone device is being shared, press the *Detect microphone* button. The input of the microphone will be output to the audio out set in the Output page.

**Please note:** to prevent unwanted audio feedback and protect your equipment, ensure the microphone isn't in close proximity to audio output device.

**WARNING:** When using separate devices for microphone and speaker, a dedicated DSP is recommended for echo cancellation and feedback elimination.

## USB Routing:

USB Routing configures USB Host options and auto switching logic.

### USB Host Priority

- Set the which USB host will take priority when both are connected at the same time (e.g., device boot up)

### Host Auto Switching

- enable / disable auto switching based on when the host was connected
  - *First in has control* will give and retain priority to the first host connected
  - *Last in takes control* will give priority to the most recent host connected

### USB Host Selected

- Manually select the USB host.

## Web-GUI - Multiview

The Multiview page allows for the configuration of multiview functionality of the WMF72. Up to 4 connected devices can be displayed in a multiview window simultaneously.

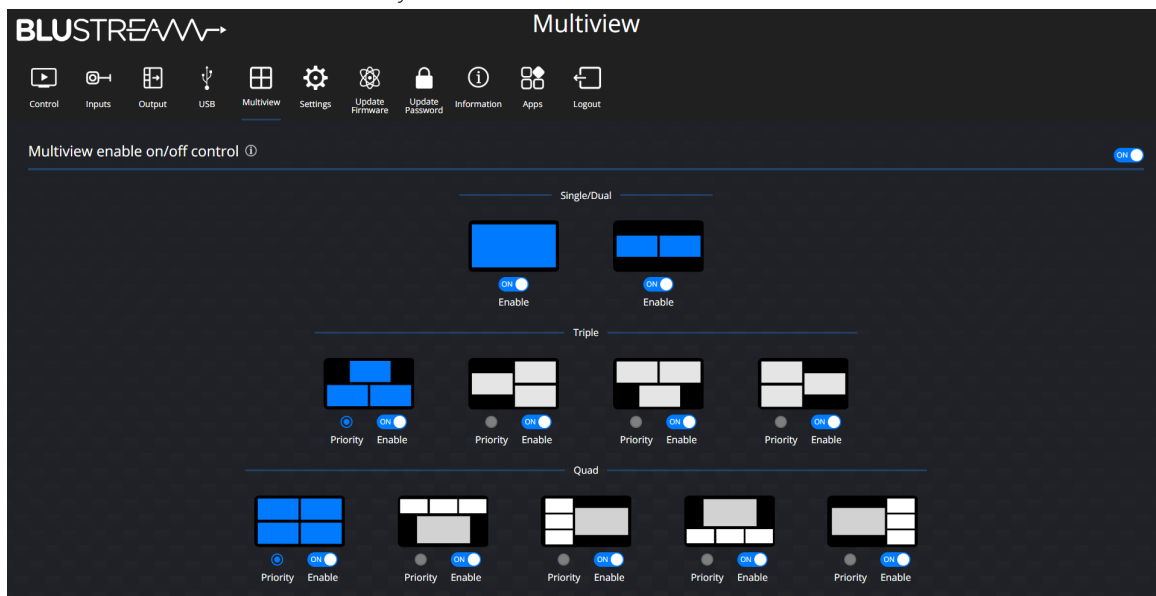

*Multiview enable ON/OFF control* enables or disables the multiview layout selection within the Control page. When enabled a user can manually change the layout via the Control page. When disabled, this function is removed for the user however multiview can still function if Auto mode is enabled.

Each individual multiview layout can be enabled or disabled with the corresponding toggle. For triple and quad sources, a priority layout can be selected to default to during auto switching mode.

**Please note:** When sharing 4 or more source devices, the video and/or audio playback performance may deteriorate due to bandwidth and processing limitations. The WMF72 has not been designed as a multiview video processor for playback of live video content.

# Web-GUI - Settings

System settings for operation of the device can be viewed and modified from this page. Once configured, the saved settings can be exported for backup purposes, or to load onto a new unit.

**Settings**

Control Inputs Output USB Multiview Settings Update Firmware Update Password Information Apps Logout

Reset System Settings Reboot Export Project Import Project Update

**General Settings**

Name	WMF72	Version	V1.1.4	GUI Version	V1.2.4
Date & Time	Enabled	Automatic date & time	OFF	Time zone	(GMT+11:00) Sydney
Auto standby	Never	Custom button function	Specific Layout Recall 1-11	Telnet Switch	Enabled
Miracast: Mice protocol	Disable	Auto download the APP to USB	Disable	Save White board or annotation files	Auto

Update

**Serial Settings**

Serial	Enable	RS-232 Baud Rate	57600	Parity	NONE
Flow control	NONE	Serial port function	RS-232 API control of WMF72	Data bits	8
Stop bits	1				

Update

**Security Level**

"Miracast" PIN code	<input type="checkbox"/>	Disable the android APK	<input type="checkbox"/>
Changing the code deletes all temporary data from base unit	<input type="checkbox"/>	Disable "Airplay"	<input type="checkbox"/>
"Airplay" PIN code	<input type="checkbox"/>	Disable "Firmware Degrade"	<input type="checkbox"/>
Telnet password	<input type="checkbox"/>	Disable Miracast	<input type="checkbox"/>
Encryption of Data: AES-256 Bit + RSA-1024Bit	<input type="checkbox"/>	Disable Win/Mac APP	<input type="checkbox"/>
Password changing deletes and removes the data of the base unit	<input type="checkbox"/>	Disable "Chromecast"	<input type="checkbox"/>

Update

**Advanced Settings**

Scheduled Reboot	Disable	Reboot time	04:00	Reboot date	Sunday Monday Tuesday Wednesday Thursday Friday Saturday
Type-C Network	Enable	USB-B Network	Enable		

Update

**Device**

Device Name	WMF72-0020	Domain Name	wmf72.local
-------------	------------	-------------	-------------

Update

**Wireless Network**

Mode	Access Point Mode	Network	Allow internet access (bridging) via LAN 1	SSID discovery and connection	Yes
Frequency	5GHz	Channel	36	MAC Address	10.2c.6b:fd:75:1e
Auto passcode change delay	5 minutes				

Update

**LAN1**

DHCP	Enable	IP Address	10.0.0.84	Subnet	255.255.255.0	Gateway	10.0.0.1
DNS1	10.0.0.2	DNS2	0.0.0.0	MAC Address	1E:F0:6D:00:00:14	Telnet port	23

Update

**LAN2**

DHCP	Enable	IP Address	0.0.0.0	Subnet	0.0.0.0	Gateway	0.0.0.0
DNS1	0.0.0.0	DNS2	0.0.0.0	MAC Address	2E:F0:6D:00:00:14	Telnet port	23

Update

**Reset System Settings:**

- Returns all device settings to their default state.

**Reboot:**

- Reboots the WMF72

**Export Projects:**

- Saves the current system configuration for the WMF72 to the local device

**Import Projects:**

- Uploads a configuration file for the WMF72

**General Settings:**

The General Settings section shows system information. The Update button will open a sub menu to configure the following items:

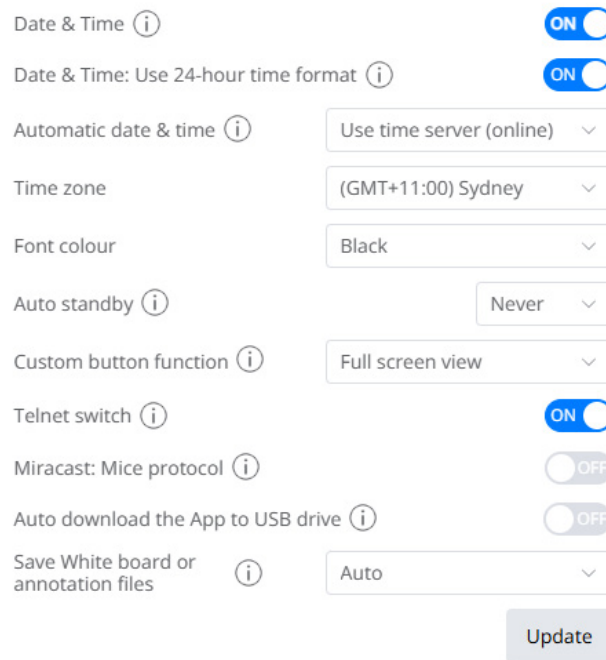

- Date & Time:
  - when enabled, the date and time will be displayed on the home screen background.
- Date & Time: Use 24-hour time format
  - change the clock format on the home screen background to 12hr or 24hr time
- Automatic Date & Time:
  - when set to *Use time server*, time will be set by an NTP server if the WMF72 is connected to the internet. When set to off, the Date and Time are able to be set manually
- Time Zone:
  - set the time zone offset

**Please note:** In order for the Chromecast feature to work reliably, the time zone of the WMF72 and your source device must match.

- Font colour
  - set the colour of the font used for the on screen display information pop up
- Auto standby:
  - specify a time in which the WMF72 enters standby mode when no connections are outputting
- Custom button function:
  - Changes the functionality of the **CUSTOM** button on the wireless dongles.
    - Force full screen forces input device to full screen playback
    - Dongle audio mute toggle mute/unmute input audio
    - Specific Layout Recall 1-11 cycle through multiview layouts 1 to 11 sequentially; if there are less multiview windows in select layout, input devices will be removed
    - Info icon pop up view WMF72's information on the HDMI output
    - Display content playback via LAN opens a window to view the main/sub HDMI output on the connected device (requires Blustream WMF Control app)
- Telnet Switch:
  - enable / disable the telnet port of the WMF72



**General Settings (continued)**

- Miracast® (MICE protocol):
  - enable / disable the ability to control a Miracast® device using WMF72 touch back feature via Miracast® over Infrastructure connection establishment protocol. Use this feature to also allow for Miracast® to be used over a Wi-Fi connection to the WMF72
- Auto download the App to USB drive:
  - enable / disable the ability for the Blustream WMF control app to be copied to an external USB drive connected to the front panel
- Save White board or annotation files:
  - when using the Whiteboard or the annotation feature, this selection alters how files are saved. It can be set to automatically save, to ask the user, or to never save

Press the Update button at the bottom of the sub menu to apply any changes.

**Serial Settings:**

The Serial Settings sections controls the parameters of the RS-232 serial port. The Update button will open a sub menu to configure the following items:

Serial ⓘ	<input checked="" type="checkbox"/> ON
Baud rate	57600 ▾
Parity	NONE ▾
Flow control	NONE ▾
Serial port function ⓘ	RS-232 API control of WM ▾
Data bits	8 ▾
Stop bits	1 ▾

- Serial:
  - enable / disable serial control via RS-232
- Baud rate:
  - select the desired RS-232 communication baud rate. Default is 57600
- Parity:
  - select RS-232 parity between even, odd or none. Default is none
- Flow Control:
  - select RS-232 flow control between XON/XOFF or none. Default is none
- Serial Port Function:
  - select 'RS-232 API control of WMF72' to receive commands via the serial port to control the WMF72
  - select 'RS-232 control Third Party devices' to send commands via the serial port to control a third party device. Commands can be programmed in the table below
- Data bits:
  - select RS-232 data bits between 5, 6, 7 or 8. Default is 8
- Stop bits:
  - select RS-232 stop bits of either 1, or 2. Default is 1

Press the Update button at the bottom of the sub menu to apply any changes.

### Custom Serial Commands:

If Serial Port Function is set to 'RS-232 control Third Party devices', the below table will be shown:

Action	Enable	Delay time (ms)	Command ⓘ
Power on	<input type="checkbox"/>	1000	Power on
Standby activated	<input type="checkbox"/>	1000	Sleep
Standby deactivated	<input type="checkbox"/>	1000	Wake up

Custom serial commands can be configured to be sent to 3rd party devices when the WMF72 performs a certain action.

- Enable
  - Press the check box to enable that command to be sent when the corresponding actions occurs.
- Delay time (ms)
  - Set how long in milliseconds to send the command after the corresponding action has occurred
- Command
  - Enter the command to be sent to the 3rd party device. Maximum length supported is 64 characters. HEX format required for terminating control characters.

Press the Update button at the bottom of the sub menu to apply any changes.

### Security Level:

The Security Level section manages configuration of important security functions. The Update button will open a sub menu to configure the following items:

- "Miracast" PIN code:
  - enable / disable a pin code for Miracast® devices. Miracast® pin code will follow WMF72's passcode found on the on screen display of the HDMI output
- Changing the code deletes all temporary data from base unit:
  - when password resets, remove data such as saved annotation pages and/or saved screenshots with annotation
- "Airplay" PIN code:
  - enable / disable a pin code for Airplay® devices. The pin code will pop-up on the WMF72 HDMI output for 8 seconds. Airplay® device will pop-up a passcode screen, please enter the 4-digit passcode
- Telnet Password:
  - enable / disable password log in for telnet (note: the password will be the Admin password). Use format "Login <password>" to log in as Admin via Telnet
- Encryption of Data: AES-256 Bit + RSA-1024Bit:
  - set the wireless dongles data transmission to use an encryption method. This is a more secure communication between devices
- Password Changing Deletes and Removes Data of Base Unit:
  - when Admin password is changed, all saved logs are cleared
- Disable the Android APK:
  - enable / disable the ability for Android devices to share content
- Disable "Airplay":
  - enable / disable the ability for Airplay® devices to share content
- Disable "Firmware Degrade":
  - enable / disable the ability for the unit to load older firmware versions

### Security Level (continued)

- Disable Miracast®:
  - enable / disable the ability for Miracast® devices to share content
- Disable Win/Mac APP:
  - enable / disable the ability for Windows or Mac devices to share content
- Disable “Chromecast”:
  - enable / disable the ability for Chromecast® devices to share content

Press the Update button at the bottom of the sub menu to apply any changes.

### Advanced Settings:

The Advanced settings section provides fine-tuning of the WMF72’s operation, and provides access to the system log. The Update button will open a sub menu to configure the following items:

**Scheduled Reboot**  OFF

Note: Before using this function, make sure that the base device time is set correctly.  
 Tips: For convenience, the base device time can be correctly automatically by connecting the base device to the Internet

**Reboot time**

Sunday  Monday  Tuesday

**Reboot on these days**  Wednesday  Thursday  Friday

Saturday

**Developer Tools**

Enable the maximum storage space for system logs and automatically turn off after 24 hours

**Enable Type-C Network**  ON

**Enable USB-B Network**  ON

- Scheduled Reboot:
  - enable / disable a scheduled reboot of the WMF72. Time and date can be set in the fields below. Ensure the time has been set correctly for proper usage of this feature
- Reboot time:
  - set the time that the unit will reboot
- Reboot on these days:
  - select on which days the unit will reboot
- Developer Tools:
  - download the system log
  - enable the WMF72 to dedicate the maximum amount of storage space for system log files
- Enable Type-C Network:
  - enable network pass-through for the USB-C port
- Enable USB-B Network:
  - enable network pass-through for the USB-B port

Press the Update button at the bottom of the sub menu to apply any changes.

**Device:**

Change device settings relating to network identification. The Update button will open a sub menu to configure the following items:

Device Name ⓘ	<input type="text" value="WMF72-0020"/>
mDNS	<input checked="" type="checkbox"/>
Domain name ⓘ	<input type="text" value="wmf72"/> .local

- Device Name:
  - set the SSID broadcast name when in the network mode is set to access point mode
- mDNS:
  - mDNS is a protocol used in network environments to resolve hostnames to IP addresses within local networks without the need for a dedicated DNS server. The WMF72 is able to be accessed via the hostname if the IP address is not known
- Domain name:
  - set the hostname to connect to

Press the Update button at the bottom of the sub menu to apply any changes.

**Wireless Network:**

The WMF72 has 3 wireless network modes to choose from. Please see the Network Connectivity Options section of this manual for an explanation of these modes (see page 21). The Update button will open a sub menu to configure the following items:

- Mode:
  - select the network mode of the WMF72 between Access Point Mode, Wireless Infrastructure Mode and LAN infrastructure mode. The available settings below will change accordingly:

Mode ⓘ	<input type="text" value="Access Point Mode"/>
Network ⓘ	<input type="text" value="Allow internet access (bridging) via LAN 1"/>
SSID discovery and connection	<input checked="" type="checkbox"/>
WMF72 SSID ⓘ	<input type="text" value="WMF72-0020"/>
Auto Passcode Change ⓘ	<input checked="" type="checkbox"/>
Passcode Change Delay	<input type="text" value="5 minutes"/>
Frequency	<input type="text" value="5GHz"/>
Area	<input type="text" value="US"/>
Channel	<input type="text" value="36"/>
Password	<input type="password" value="....."/>

**Wireless Network (continued)**

**Access Point Mode:**

- Network:
  - select the method of allowing external internet access (bridging the network) to the WMF72 between LAN 1, LAN 2 or disabled (see page 24 for more details)
- Auto change password:
  - this will automatically change the internal access points Wi-Fi password after the specified time limit
- SSID discovery and connection:
  - enable / disable the SSID broadcast of the WMF72. If disabled, the WMF72 will not broadcast a Wi-Fi network
- Frequency:
  - select the Wi-Fi broadcast frequency between 2.4GHz or 5GHz
- Area:
  - select the locale to ensure valid Wi-Fi channels are used

**Please note:** In order for the Chromecast® feature to work reliably, the Access Point area of the WMF72 must be set correctly.

- Channel:
  - select the Wi-Fi broadcast channel within the specified frequency range
- Password:
  - set the password for connecting to the Wi-Fi network

**Please note:** When in Wi-Fi access point mode, the internal Wi-Fi access point handles its own DHCP on the 192.168.xxx.xxx range.

**Wireless Infrastructure Mode:**

Dongle connection method:

- Dongle connects to WMF72 via Wireless Network.
  - Select the SSID of the Third Party Network that the dongles and in-built Wi-Fi of the WMF72 will connect to, and enter the password
  - Press the tick to validate the password

Mode ⓘ	Wireless Infrastructure Mode	▼
Dongle connection method ⓘ	Dongle connects to WMF72 via Wireless Net	▼
Select SSID	Blustream(Signal level: 92%)	▼ 🔍
Password	<input type="password"/>	✓
<input type="button" value="Update"/>		

Dongle connection method:

- Dongle connects to the WMF72 via selected LAN:
  - Select the SSID of the Third Party Network that the in-built Wi-Fi of the WMF72 will connect to, and enter the password
  - Press the tick to validate the password
  - Select the SSID of the LAN network that the WMF72 is connected to via LAN port 1/2 that the dongles will connect to, and enter the password
  - Press the tick to validate the password

Mode ⓘ	Wireless Infrastructure Mode	▼
Dongle connection method ⓘ	Dongle connects to WMF72 via selected LAN	▼
Select SSID	Blustream(Signal level: 92%)	▼ 🔍
Password	<input type="password"/>	✓
Select SSID for dongle connection	Blustream_Guest(Signal level: 92%)	▼ 🔍
Password	<input type="password"/>	✓
<input type="button" value="Update"/>		

**LAN Infrastructure Mode:**

- Select the SSID of the LAN network that the WMF72 is connected to via LAN port 1/2 that the dongles will connect to, and enter the password
- Press the tick to validate the password

Mode ⓘ

Select SSID for dongle connection

Password

Press the Update button at the bottom of the sub menu to apply any changes.

**LAN1 / LAN2**

The LAN1 / LAN2 configuration sections allows for configuring the hard wired LAN ports. The Update button will open a sub menu to configure the following items:

- DHCP:
  - when DHCP is enabled, the corresponding LAN port will get its IP address via the DHCP server/router on the network and the static IP settings will be disabled
  - when DHCP disabled, you set static IP settings
- IP Address:
  - set the static IP address of the corresponding LAN port.
- Subnet:
  - set the subnet mask of the corresponding LAN port.
- Gateway:
  - set the gateway address of the corresponding LAN port.
- DNS1 / DNS2:
  - set the DNS server(s) of the corresponding LAN port.
- Telnet Port:
  - set the Telnet port; both LAN ports will utilize the same telnet port

DHCP

IP Address

Subnet

Gateway

DNS1

DNS2

Telnet Port ⓘ

Wired Authentication

Authentication Status

## Web-GUI - Update Firmware

The Update Firmware page provides the ability to upload new firmware directly to the WMF72 by pressing the Upload WMF72 Firmware button and selecting the firmware file.

The Automatic upgrading function allows for dongles to have their firmware updated automatically when they are connected for pairing to the WMF72 USB pairing ports. It is recommend to leave this function enabled..

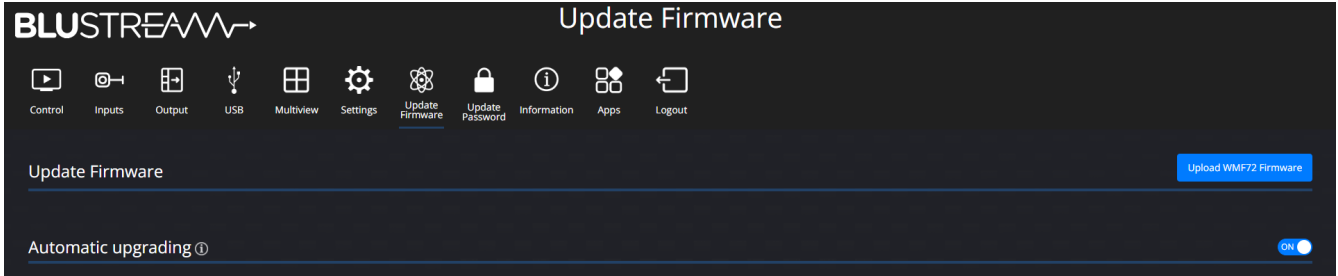

## Web-GUI - Update Password

Passwords for the Admin (Blustream) user, Guest user, and in-built device Wi-Fi can be set from this page.

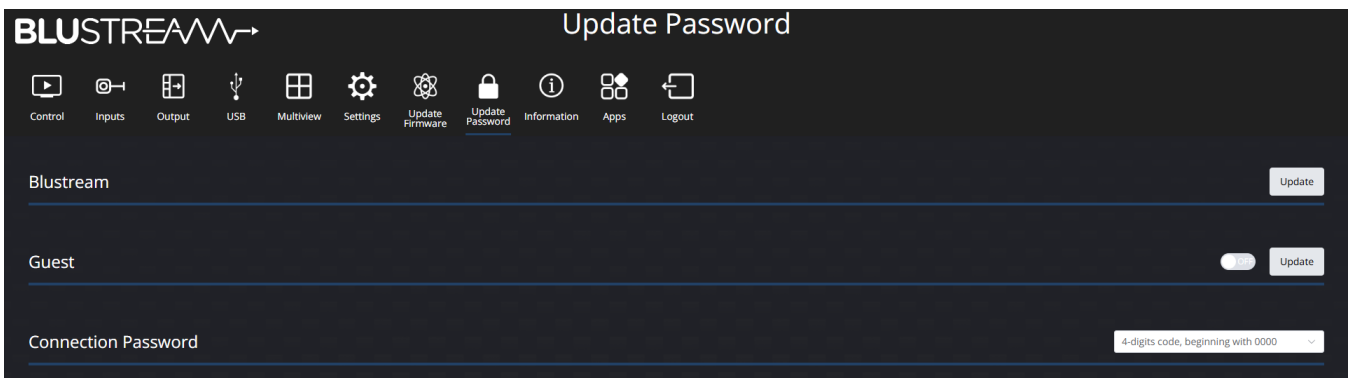

### Blustream:

Pressing the update button opens a sub menu where the password for the user can be changed.

### Guest:

The Guest user can be enabled or disabled using the ON / OFF toggle.

Pressing the update button opens a sub menu where the password for the user can be changed.

### Connection Password:

The password for the WMF72's in-built Wi-Fi can be set to either be an 8 digit number starting with 0000 and then 4 random digits, or 8 random digits. The generated password will be displayed on the on screen display.

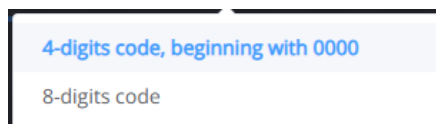

## Web-GUI - Information

The Information page displays the model name, serial number, web-GUI firmware version and MCU firmware version of the WMF72.

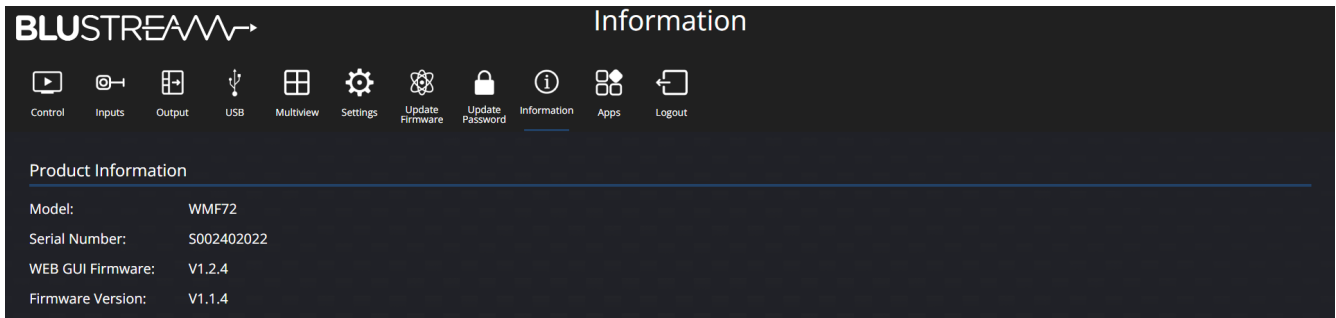

## Web-GUI - Apps

The Apps page allows for a user to download the Blustream WMF Control app for their specific device. The app can be useful in allowing a user who frequently utilises the WMF72 to connect with greater speed and performance. Using the app over certain wireless connections may also help improve stability. It is not necessary to utilise the app to connect and transmit video to the WMF72.

Individual Apps are available for Android, Windows (via installer or as a portable file) or MacOS X.

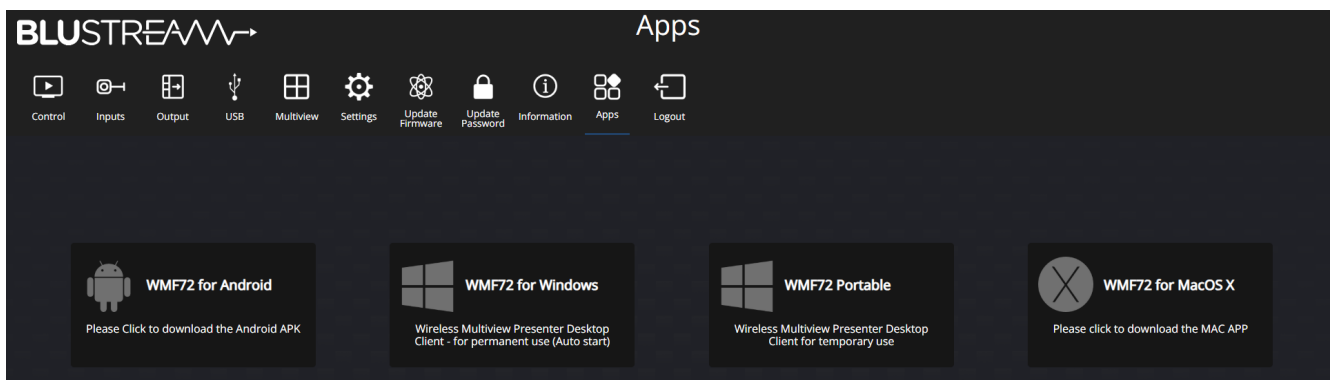

### Apps Download

The links in the Apps page of the WMF72 GUI will directly download the app to their device. The downloads can also be obtained from the WMF72 product page on the Blustream website in the Downloads section.



## Specifications

- **Video Input Connectors:** 1 x HDM Type A, female, 1 x USB Type C, female,
- **Video Output Connectors:** 2 x HDMI Type A, 19-pin, female
- **Audio Output Connectors:** 5-Pin Phoenix connector (2ch balanced/un-balanced analogue audio)
- **RS-232 Serial Port:** 1 x 3-pin Phoenix connector
- **TCP/IP Control:** 2 x RJ45, female (1000Mbps x2)
- **USB Connector:** 3 x USB 3.0 Type A female, 1 USB 3.0 Type B female
- **USB Pairing Connector:** 1 x USB 2.0 Type A female, 1 x USB 2.0 Type C female
- **Wi-Fi Antenna Connections:** 3 x SMA, female connector, MIMO antennas (2.4G & 5G, WIFI IEEE 802.11 b/g/n/ac up to 1200Mbps)
- **Wi-Fi Encryption:** AES WPA PSK, WPA2 PSK
- **Wi-Fi Specification for Europe only:** 2.4GHz EIRP < 20dBm  
5.150~5.250GHz EIRP < 23dBm  
5.725~5.850GHz EIRP < 13.98dBm
- **Dimensions (W x H x D):** 220mm x 27mm x 161mm (excluding antennas)
- **Shipping Weight:** 1.5kg
- **Operating Temperature:** 0°C to 45°C (32°F to +113°F)
- **Storage Temperature:** -20°C to 70°C (-4°F to +158°F)
- **Power Supply:** 24V/5A DC

**NOTE:** Specifications are subject to change without notice. Weights and dimensions are approximate.

## Package Contents

- 1 x WMF72
- 1 x 24V/5A DC Power Supply
- 1 x 3-pin Phoenix Connector (RS-232)
- 1 x 5-pin phoenix connector (audio)
- 3 x Antenna
- 1 x Mounting Kit
- 1 x Quick Reference Card

### Power Supply Specification:

Model: TDX-2405000

Rated Input: 100-240vAC 50/60Hz 3.0A

Rated Output: 24.0v 5A 120W

Includes: any 2 of US, UK, EU, AU power cords

Manufacturer: Shenzhen Teng Da Xing Electron Co. Ltd.

Address: 3rd Floor, Building 1, Chaxi Industrial Zone, Sanwei Community, Hangcheng Street, Bao'an District, Shenzhen

## Maintenance

Clean this unit with a soft, dry cloth. Never use alcohol, paint thinner or benzene to clean this unit.

# RS-232 Configuration and Telnet Commands

The WMF72 can be controlled via serial and TCP/IP.

The default RS-232 communication settings are:

Baud rate: 57600

Data bits: 8

Stop bits: 1

Parity bit: none

The following pages list all available serial / IP commands.

## Commonly used Serial Commands

There are several commands that are commonly used for control and testing:

**STATUS** Status will give feedback on the switcher such as outputs on, type of connection, etc.

**PON** Power on

**POFF** Power off

**OUTON/OFF** Toggling the main output ON or OFF as required

Example: OUTON (This would turn the main output on)

**OUT FRyy** (yy is the input)

Example: OUT FR04 (This would switch the main output to source input 4)

## Common Mistakes

- Carriage return: Some programs do not require the carriage return where as other will not work unless sent directly after the string. In the case of some Terminal software the token <CR> is used to execute a carriage return. Depending on the program you are using this token maybe different. Some other examples that other control systems deploy include \r or 0D (in hex)
- Spaces: Blustream commands do not require space between commands unless specified. There may be some programs that require spacing in order to work.
  - How the string should look is as follows: OUTON
  - How the string may look if spaces are required: OUT{Space}ON
- Baud rate or other serial protocol settings not correct

# RS-232 Configuration and Telnet Commands

COMMAND	ACTION
? / HELP	Print help information
STATUS	Print system status and port status
INSTA	Print All Input Status
OUTSTA	Print All Output Status
CTRLSTA	Print All Control Status
AUDSTA	Print All Audio Status
SECSTA	Print All Security Status
NETSTA	Print All Network Status
PON/OFF	Set System Power On Or Off
KEY ON/OFF	Set System Key Control On Or Off
RESET	Reset System To Default Setting
REBOOT	Set System Reboot
OSD HOME	Force to Home Screen
OUT MUTE ON/OFF	Set Output Video Mute On Or Off
OUT OSD ON/OFF	Show the base device name and password when mirroring
OUT DISPLAY MODE xx	Set Output Dual Display Mode to xx xx = 1: Mirroring xx = 2: Multiview + Single view xx = 3: Single view + Multiview
OUT ooo FR iii	Set Output ooo From Input yyy
OUT ooo W widx FR iii	Set Output ooo Multiview Window widx From Input iii ooo = 00 all output widx = 01-04 Multiview Window iii = 01-n Select input iii = Name or MAC or Serial Number
AUTO SWITCH ON/OFF	Set AUTO SWITCH ON/OFF
LAYOUT TRIPLE DF yy	Set Default Triple Window Layout To yy yy=[03]: Triple-T yy=[04]: Triple-L yy=[05]: Triple-B yy=[06]: Triple-R
LAYOUT QUAD DF yy	Set Default Quad Window Layout To yy yy=[07]: Quad yy=[08]: Quad-B yy=[09]: Quad-R yy=[10]: Quad-T yy=[11]: Quad-L
OUT LAYOUT yy	Set Multiview Window Layout To yy yy=[01]: Single Source yy=[02]: Dual yy=[03]: Triple-T yy=[04]: Triple-L yy=[05]: Triple-B yy=[06]: Triple-R yy=[07]: Quad yy=[08]: Quad-B yy=[09]: Quad-R yy=[10]: Quad-T yy=[11]: Quad-L

COMMAND	ACTION
OUT xx RES rr	Set Output Scaler Resolution To rr xx=[1...2]:1:Main,2:Sub xx = [00..01]: Select One Output Port rr = 00: Auto rr = 01: 720P@50Hz rr = 02: 720P@60Hz rr = 03: 1080P@30Hz rr = 04: 1080P@50Hz rr = 05: 1080P@60Hz rr = 06: 3840x2160P@30Hz (Only for Main Output) rr = 07: 3840x2160P@50Hz (Only for Main Output) rr = 08: 3840x2160P@60Hz (Only for Main Output) rr = 09: 4096x2160P@30Hz (Only for Main Output) rr = 10: 4096x2160P@50Hz (Only for Main Output) rr = 11: 4096x2160P@60Hz (Only for Main Output)
SEC xx ON/OFF	Set Security Level xx = 03: Changing the code deletes all temporary data from base unit xx = 04: "Airplay" PIN code xx = 05: Telnet password xx = 06: Encryption of Data: AES-256 Bit + RSA-1024Bit xx = 07: Password changing deletes and removes the data of the base unit xx = 08: "Miracast" PIN code xx = 09: Disable the android APK xx = 10: Disable "Airplay" xx = 11: Disable "Firmware Degrade" xx = 12: Disable Miracast xx = 13: Disable Win/Mac APP xx = 14: Disable "Chromecast"
AUD OUT xx	Audio output selection xx = 00 Set output audio to Analogue and HDMI. xx = 01 Set output audio to HDMI only. xx = 02 Set output audio to Analogue only. xx = 03 Set output audio to USB only.
AUDIO MODE yy	Set Output Audio From Input yy yy=[01]: Audio Mixer yy=[02]: Single Input source yy=[03]: Single Input Window yy=[04]: Single Input First IN yy=[05]: Single Input Last IN
AUDIO MUTE yy ON/OFF	Mute input when in Audio Mixer Mode yy=[1-15] Connected Input Devices
AUDIO FR yy	Set Output Audio From Input iii [can only use on Single Input Source] iii = 01-n Select input iii = Name or MAC or Serial Number
AUDIO FR W widx	Set Output Audio From Window widx [can only use on single Input Window] widx = 01-05 Multiview Window
VOL vw	Set Volume Level vw On Output
INSTART iii	Set Input to Start Sharing Input
INSTOP iii	Set Input to Stop Sharing Input

# RS-232 Configuration and Telnet Commands

COMMAND	ACTION	COMMAND	ACTION
INFORCE xxx	Set Input xxx Fullscreen Sharing xxx = 000 : Stop fullscreen sharing xxx = 000 : Stop fullscreen sharing xx = 001-00n Fullscreen selected Input xx = IP Address xx = Name xx = MAC xx = Serial Number xx = Mac address	USB CONTROL x	Set USB host auto-switching control method x = 1 First in has control, 2 Last in takes control
STBYON	Enables Auto Standby mode	HOST PRIORITY x	Set host priority when connecting with both USB-C and USB-B hosts at the same time x = 1 USB-C, 2 USB-B
STBYOFF	Disables Auto Standby mode		
STBDLY xx	Set Auto standby Delay xx = 00 STBYOFF xx = 01-30 = time in minutes		
OUT xx SIDEBAR ON/OFF	Statusbar show/Statusbar hide xx = [0...2]:0:All,1:Main,2:Sub		
PAIR	Get button info		
PAIRREMOVE xx	Remove paired dongle		
RS232BAUD x	Set RS232 Baud Rate To x x = 1 2400, 2 4800, 3 9600, 4 19200, 5 38400, 6 57600 (Default), 7 115200		
LAN yy DHCP ON/OFF	Set Auto IP(DHCP) On Or Off		
LAN yy IP xxx.xxx.xxx.xxx	Set IP Address		
LAN yy GW xxx.xxx.xxx.xxx	Set Gateway Address		
LAN yy SM xxx.xxx.xxx.xxx	Set Subnet Mask Address		
LAN yy TCPPORT xxxx	Set TCP/IP Port		
LAN yy RB	Set Network Reboot And Apply New Config!!!		
LAN yy DNS xxxx	Set DNS Domain Name To xxxx yy=1 LAN1 yy=2 LAN2		
WIFI ON/OFF	Turn Wi-Fi access point On or Off		
WIFI FREQ ff CH ccc	Set Wi-Fi access point frequency and channel ff = 2: 2.4Ghz ff = 5: 5Ghz ccc = For 2.4Ghz: 1-11 ccc = For 5Ghz: 36, 40, 44, 48, 149, 153, 157, 161, auto		
WIFI SSID xxxx	Set Wi-Fi SSID		
WIFI PASS xxxx	Set Wi-Fi PASS		
REFRESH PASS xx	Change Wi-Fi Password xx = 00: Change password xx = 01: 5 mins xx = 02: 30 mins xx = 03: 1 hour xx = 04: 24 hours xx = 05: Never		
HOST x FR ALL	Set USB devices connect from x host x = 1 USB-C, 2 USB-B, 3 Wireless		
AUTO-SWITCHING ON/OFF	Set USB host auto-switching On/Off		

# Certifications

## FCC Notice

This equipment has been tested and found to comply with the limits for a Class B digital device, pursuant to part 15 of the FCC Rules. These limits are designed to provide reasonable protection against harmful interference in a residential installation. This equipment generates, uses, and can radiate radio frequency energy and, if not installed and used in accordance with the instructions, may cause harmful interference to radio communications. However, there is no guarantee that interference will not occur in a particular installation. If this equipment does cause harmful interference to radio or television reception, which can be determined by turning the equipment off and on, the user is encouraged to try to correct the interference by one or more of the following measures:

- Reorient or relocate the receiving antenna.
- Increase the separation between the equipment and receiver.
- Connect the equipment into an outlet on a circuit different from that to which the receiver is connected.
- Consult the dealer or an experienced radio/TV technician for help.

**CAUTION** - changes or modifications not expressly approved by the party responsible for compliance could void the user's authority to operate the equipment.

## CANADA, INDUSTRY CANADA (IC) NOTICES

This Class B digital apparatus complies with Canadian ICES-003.

Operation is subject to the following two conditions: (1) this device may not cause interference, and (2) this device must accept any interference, including interference that may cause undesired operation of the device.

## CANADA, AVIS D'INDUSTRY CANADA (IC)

Cet appareil numérique de classe B est conforme aux normes canadiennes ICES-003.

Son fonctionnement est soumis aux deux conditions suivantes : (1) cet appareil ne doit pas causer d'interférence et (2) cet appareil doit accepter toute interférence, notamment les interférences qui peuvent affecter son fonctionnement.

## CORRECT DISPOSAL OF THIS PRODUCT

This marking indicates that this product should not be disposed with other household wastes. To prevent possible harm to the environment or human health from uncontrolled waste disposal, recycle it responsibly to promote the sustainable reuse of material resources. To return your used device, please use the return and collection systems or contact the retailer where the product was purchased. They can take this product for environmentally safe recycling.





[www.blustream.com.au](http://www.blustream.com.au)

[www.blustream-us.com](http://www.blustream-us.com)

[www.blustream.co.uk](http://www.blustream.co.uk)