



JTS® PROFESSIONAL CO., LTD
www.jts.com.tw



59508-084-01

JTS®

JTS PROFESSIONAL CO., LTD.

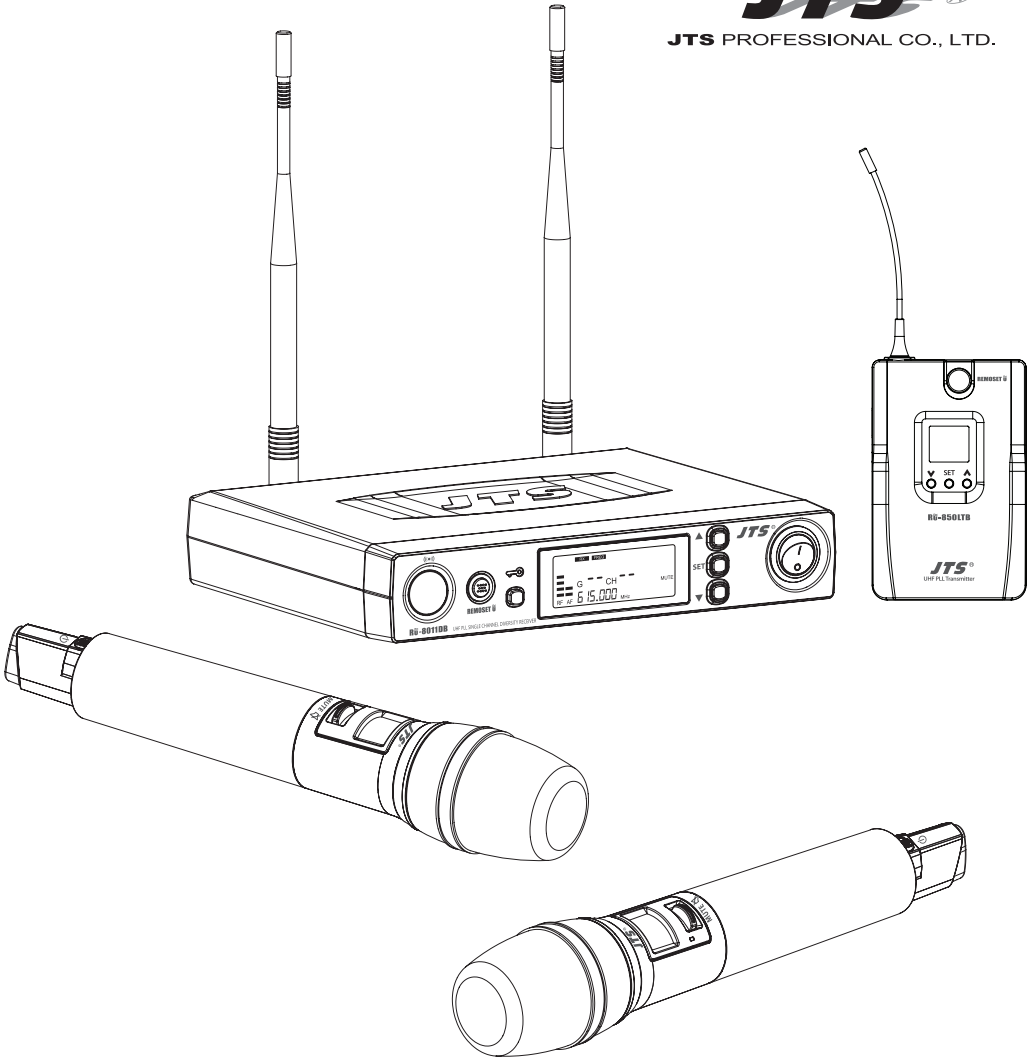

Instruction Manual

UHF PLL

R $\tilde{\text{U}}$ -8011(D)DB / R $\tilde{\text{U}}$ -8012DB

R $\tilde{\text{U}}$ -850(L)TH / R $\tilde{\text{U}}$ -850(L)TB



With JTS **REMOSET $\tilde{\text{U}}$** Ultrasonic Synchronizing Technology

One year product warranty

Product Model		Equipment serial number	
Customer name		Contact number	
Address			
Purchase date			
Selling store stamp	Be sure to put store stamp and fill in purchase date for the warranty to be effective!		

Warranty description

1. Be sure to put the warranty label indicating purchase date on the bottom of equipment to ensure your interest in maintenance and service.
2. Product warranty, starting on the purchase date indicated on “warranty label”, will last for one year; if the equipment does not have “warranty label”, the warranty period is 15 months from the manufacturing date. If a microphone is broken but not sent back with the equipment, the warranty period is 15 months from the manufacturing date of the microphone.
3. Within the warranty period, if the equipment is broken under normal use as instructed in manual, please contact the original selling store for repair.
4. When the product is returned for repair, to facilitate proper determination of cause of malfunction and of whether repair fee is needed, please ship back the equipment and microphone together.
5. Within the warranty period, our company provides repair service at no cost except for the following conditions that parts and repair may be charged:
 - a. Damages due to natural disaster or irresistible outside forces.
 - b. Damages due to drop, water, moisture, corrosion, foreign objects, missing components.
 - c. The warranty does not cover consumable parts. (such as microphone capsule, ball grille etc.)
 - d. Those without “warranty label” on equipment or with “warranty label” being damaged and failing to identify warranty period.
6. Please keep the warranty properly. No replacement will be made if the warranty is missing.

Table of Contents

1. Notes for system operations	1
2. Features	1
3. Specifications	2
3-1 UHF PLL single/dual-channel diversity receiver	2
3-2 UHF PLL hand-held transmitter	4
3-3 UHF PLL body-pack transmitter	5
3-4 Optional condenser microphone	6
4. Description of parts	8
4-1 UHF PLL single-channel diversity receiver // Rũ-8011D	8
4-2 UHF PLL single-channel diversity receiver // Rũ-8011DB	10
4-3 UHF PLL dual-channel diversity receiver // Rũ-8012DB	12
4-4 UHF PLL hand-held transmitter // Rũ-850TH	14
4-5 UHF PLL hand-held transmitter // Rũ-850LTH	15
4-6 UHF PLL body-pack transmitter // Rũ-850TB	16
4-7 UHF PLL body-pack transmitter // Rũ-850LTB	17
4-8 Accessories	18
4-9 Optional Condenser Microphone	18
5. Connecting	21
5-1 How to connect the receiver	21
5-2 Transmitter installation // Rũ-850TH/Rũ-850LTH/Rũ-850TB / Rũ-850LTB	23
6. Instructions for use	24
6-1 How to use // Rũ-8011D	24
6-2 How to use // Rũ-8011DB	27
6-3 How to use // Rũ-8012DB	30
6-4 How to use // Rũ-850TH / Rũ-850TB	33
6-5 How to use // Rũ-850LTH / Rũ-850LTB	34
7. Notes for the product	36

1. Notes for system operations

- Before connecting the power, check that the power requirement shown on the unit is the same as the power output on the adaptor supplied.
- Do not leave the unit at where the humidity and temperature are high.
- Dry your hands before operating the system.
- Keep the unit away from fire and heat source.
- Turn the volume to minimum at both the mixer and amplifier before setting up the system.

2. Features

- 6 groups are provided as default. Every group contains up to 22 default channels.
- There are in total 1,440 channels to choose from.
- 36MHz bandwidth.
- The patented **REMOSET**  ultrasonic pairing for synchronized setting of all parameters
- Channel scan
- Adjustable receiving sensitivity
- Digital volume control
- Automatic microphone power off

3. Specifications

3-1 UHF PLL single/dual-channel diversity receiver

Model	R̃-8011D	R̃-8011DB	R̃-8012DB
Frequency Oscillation Mode	Phase-locked loop (PLL)		
Carrier Frequency Range	470~960 MHz		
Remoset Frequency	Ultrasonic		
Diversity	Antenna diversity		
Bandwidth	36MHz		
Signal/Noise Ratio	>105dB(A)		
Total Harmonic Distortion (Thd)	<0.6%@1KHz		
Receiving Sensitivity	-95dBm , S/N>80dB		
Image Rejection Ratio	>80 dB		
Frequency Response	60Hz~15KHz±2dB	50Hz~16KHz±2dB	
Antenna Type	1/4λ Fixed antenna	1/2λ BNC detachable	
Antenna Booster Power	None	DC12~15V/100mA	
Function Display By	LCD		
Contents Of Display	Group, channel, antenna A/B, muting level, AF indication, RF indication, channel scanning, output level attenuation, volume indication	Group, channel, frequency, battery level, antenna A/B, muting level, AF indication, RF indication, channel scanning, output level attenuation, volume indication	
Control Functions	Power, group, channel, muting level, channel scan (on/off), button lock, volume, output attenuation (XLR)	Power, group, channel, frequency, muting level, button lock, volume, output attenuation (XLR), channel scan (on/off)	
Audio Frequency Output Level	Ref : ±22.5KHz Dev@1KHz Tone		
	ψ6.3 Phone Jack : -10dBV		
	XLR Jack : -4dBV(Line) 、 -24dBV(MIC)		
Audio Frequency Output Impedance	600Ω		

Model	R̃-8011D	R̃-8011DB	R̃-8012DB
Muting	Noise muting and tone code locking		
Output Port	1 x balanced XLR jack 1 x unbalanced ϕ6.3 jack		2 x balanced XLR jack 2 x unbalanced ϕ6.3 jack
Power Supply	DC12~15V/300mA		12~15V DC / 500mA
Dimension (Mm)	212.3mm (W) x 38.3mm (H) x 144mm (L)		

3-2 UHF PLL hand-held transmitter

Model	Rũ-850TH	Rũ-850LTH
Frequency Oscillation Mode	Phase-locked loop (PLL)	
Carrier Wave Frequency Range	470~960 MHz	
Remoset Frequency	Ultrasonic	
RF Power Output	10mW/50mW(as per local regulations)	
RF Stability	< $\pm 10\text{KHz}@F_c$	
Modulation Frequency Shift	$\pm 48\text{KHz}$	
Harmonic Radiation	<-50dBc	
Functions	Mute, auto off, sensitivity adjustment, low power indication	
Display By	LED	LCD+LED
Controls	Power, mute	Power, mute, group, channel, frequency, sensitivity adjustment, auto off, button lock
Battery	AA alkali battery or MiNH rechargeable battery x 2	
Charging	No	Yes
Dimension	51mm (W) x 269mm (H) x 26mm (L)	

3-3 UHF PLL body-pack transmitter

Model	R_U-850TB	R_U-850LTB
Frequency Oscillation Mode	Phase-locked loop (PLL)	
Carrier Wave Frequency Range	470~960MHz	
Remoset Frequency	Ultrasonic	
RF Power Output	10mW/50mW(as per local regulations)	
RF Stability	<±10KHz@Fc	
Modulation Frequency Shift	±48KHz	
Harmonic Radiation	<-50dBc	
Functions	Mute, auto off, input level attenuation, sensitivity adjustment, low power indication	
Display By	LED	LCD+LED
Input Port	4 pin Mini XLR	
Controls	Power, mute	Power, mute, group, channel, frequency, sensitivity adjustment, input level attenuation, auto off
Battery	AA alkali battery or MiNH rechargeable battery x 2	
Charging	No	Yes
Dimension	62mm (W) x 97mm (H) x 20mm (L)	

3-4 Optional condenser microphone

Lavaliere microphone

Model	CM-501	CM-201i	CM-125i
Connector	4-pin mini XLR	4-pin mini	4-pin mini XLR
Frequency Response	100~15,000 Hz	XLR60~15,000 Hz	50~18,000 Hz
Polar Pattern	Cardioid	Omni-directivity	
Sensitivity (at 1000Hz)	-60 ± 3dB	-60 ± 3dB	-53 ± 3dB
Impedance	2.2K Ω		4.4K Ω
Max. SPL for 1% THD	130dB		
Dimension (mm)	Ø10.1mm (W) x 26.4mm (H)	Ø5mm (W) x 9mm (H)	Ø4mm (W) x 11mm (H)
Net Weight	21.5g	20.7g	7g (cable not included)

Headset microphone

Model	CM-214i	CM-214Ui	CM-214ULi
Connector	801C4 (4P Mini XLR)	4P Mini XLR	801C3 (3P Mini XLR) 801C4 (4P Mini XLR) 801CS (3.5 stereo plug)
Option Connector	801C3 (3P Mini XLR) 801CS (3.5 stereo plug) 801CR		801CR
Frequency Response	60~15,000 Hz	30~18,000 Hz	100 ~ 18,000Hz
Polar Pattern	Omni-directional	Cardioid	
Sensitivity (at 1000Hz)	-60±3 dB	-68±3 dB	-65±3 dB
Impedance	1.8kΩ	680Ω	1.8kΩ
Max. SPL for 1% THD	130dB		120dB
Dimension(mm)	125mm(W) x 134mm(H)x 157mm(D)	205mm(W)x 134mm(H)x 157mm(D)	125mm(W)x 134mm(H)x 157mm(D)
Net Weight	32.9g	38.4g	18g (cable excluded)

Model	CM-235i	CX-504
Connector	801C4 (4P Mini XLR)	4P Mini XLR
Frequency Response	50~18,000 Hz	30~18,000 Hz
Polar Pattern	Omni-directional	Cardioid
Sensitivity (at 1000Hz)	-53 ± 3dB	-68 ± 3dB
Impedance	1.8kΩ	680Ω
Max. SPL for 1% THD	130dB	130dB
Dimension(mm)	155mm(W)x 134mm(H)x 157mm(D)	285mm(W)x 55mm(H)x 111.3mm(D)
Net Weight	17g (cable excluded)	56.3g

Ear-hook microphone //

Model No	CM-801 / CM-804i	CM-8015 / CM-825i
Connector	801C4 (4P Mini XLR)	801C4 (4P Mini XLR)
Option Connector	801C3 (3P Mini XLR) 801CS (3.5 stereo plug) 801CR	801C3 (3P Mini XLR) 801CS (3.5 stereo plug) 801CR
Frequency Response	60~15,000 Hz	50~18,000 Hz
Polar Pattern	Omni-directional	Omni-directional
Sensitivity (at 1000Hz)	-64±3 dB	-53±3 dB
Impedance	1.8kΩ	1.8kΩ
Max. SPL for 1% THD	130dB	130dB

4. Description of parts

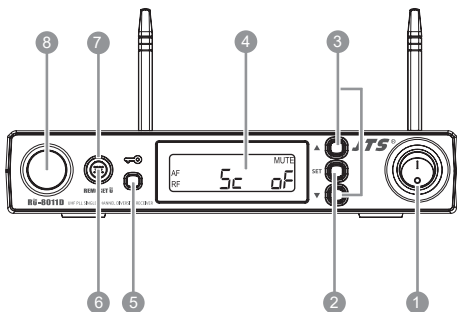

4-1 UHF PLL single-channel diversity receiver // **RŪ-8011D**

Front panel

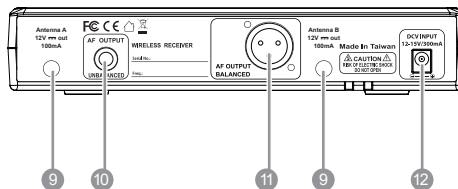

Rear panel





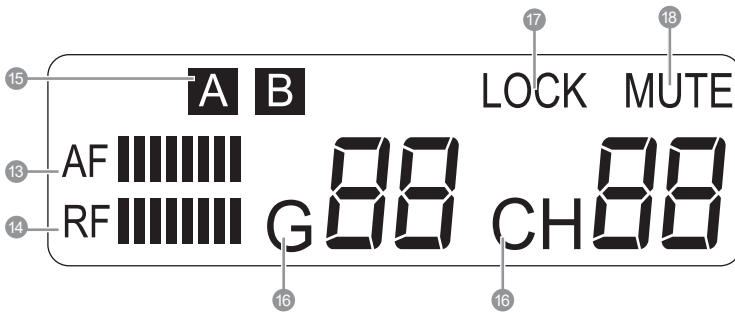

- ① Power: | means "ON" and ○ means "OFF"
- ② SET: this is for function settings. Push and hold for 2 seconds to enter the setting mode. Push "SET" repeatedly to search for the function you wish to set.
- ③ ▲/▼ In the setting mode, push ▲/▼ to change the function parameter
In the non-setting mode: push ▲/▼ to adjust volume
- ④ LCD display
- ⑤ Lock : push and hold "Lock" for 2 seconds to lock the buttons in order to prevent pushing any button by accident.
- ⑥ Remoset u : this allows user to synchronize the transmitter after modifying a parameter. Push " **REMOSET**  " to synchronize the settings to the transmitter.
- ⑦ Remoset indicator : this shows the current pairing status. It flashes rapidly when data is being transmitted and the flashing stops when the synchronization is completed. However, the flashing slows down if synchronization fails after a period of time of pairing attempt.
- ⑧ Ultrasonic transmission unit: it transmits digital pairing data at ultrasonic frequency. When setting, direct the ultrasonic receiving element of the microphone to the ultrasonic transmitting unit of the receivers. The effective range is 30° on both sides with the optimized distance at 30cm.
- ⑨ Receiving antenna: fixed antenna of 1/4 wave length
- ⑩ 6.3mm phone jack: unbalanced audio output jack
- ⑪ 3P XLR male: balanced audio output jack
- ⑫ DC power socket: for 12~15V DC / 300mA power supply

RÜ-8011D LCD Display



In the non-setting mode, the LCD looks like :

- 13 AF  : Audio signal strength
- 14 RF  : RF signal strength
- 15 **A B** : Antenna A/B
- 16 G  / CH  : Group / channel
- 17 LOCK : Button lock engaged
- 18 MUTE : Receiver mute

4-2 UHF PLL single-channel diversity receiver // **RÜ-8011DB**

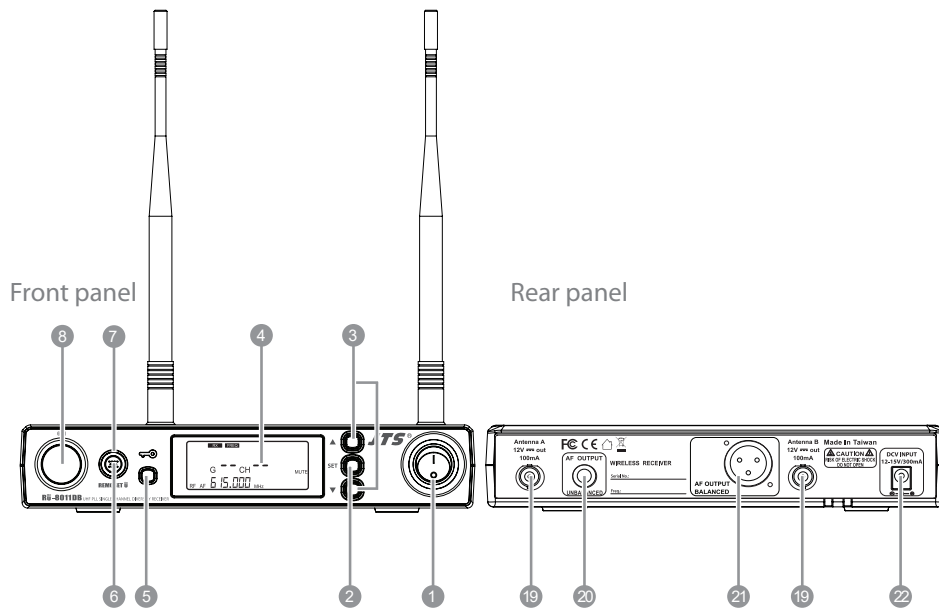



① ~ ⑧ : See page 8.

- ⑱ Female BNC antenna port: the 50Ω BNC antenna is connected here. It also provides a booster power of 12~15 DC / 100mA for an external antenna booster.
- ⑳ 6.3mm phone jack: unbalanced audio output jack
- ㉑ 3P XLR male: balanced audio output jack
- ㉒ DC power socket: for 12~15V DC / 300mA power supply

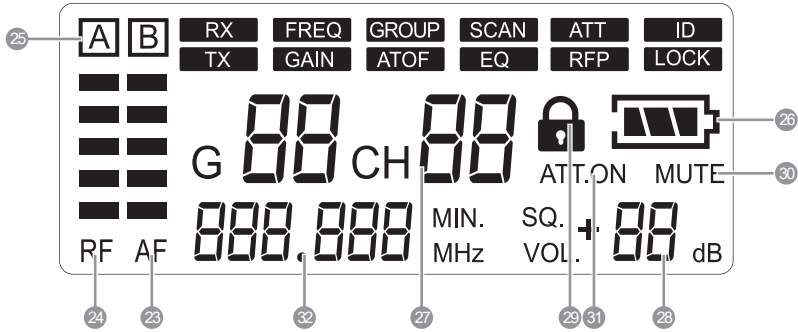
RÜ-8011DB LCD Display



In the non-setting mode, the LCD looks like :

- 23 **AF** : Audio signal strength
- 24 **RF** : RF signal strength
- 25 **A B** : Antenna A/B
- 26  : Transmitter battery level
- 27 **G 00 / CH 00** : Group/channel
- 28 **VOL. + 00 dB** : Volume
- 29  : Button lock
- 30 **MUTE** : Receiver mute
- 31 **ATT.ON** : Output attenuation
- 32 **000.000 MHz** : Frequency

4-3 UHF PLL dual-channel diversity receiver // **RÜ-8012DB**

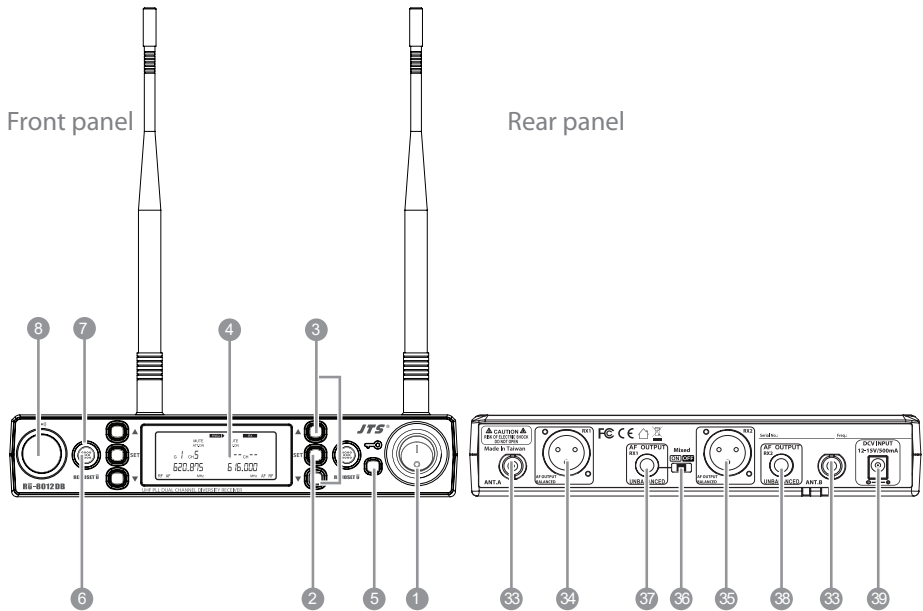

① ~ ⑧ : See page 8.

③③ Female BNC antenna port: the 50Ω BNC antenna is connected here. It also provides a booster power of 12~15 DC / 100mA for an external antenna booster.

③④ Male XLR (RX1): RX1 balanced audio output jack

③⑤ Male XLR (RX2): RX2 balanced audio output jack

③⑥ Mixing: it allows the unbalanced audio signals from RX1 and RX2 to be mixed to RX1.

③⑦ 6.3mm phone jack (RX1): RX1 unbalanced audio output jack

③⑧ 6.3mm phone jack (RX2): RX2 unbalanced audio output jack

③⑨ DC power socket: for 12~15V DC / 500mA power supply

Rũ-8012DB LCD Display

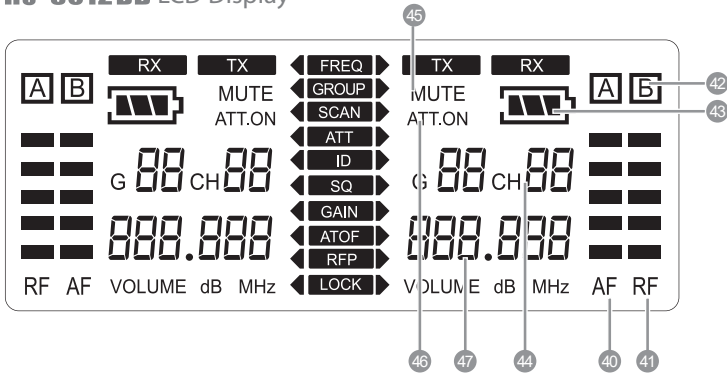

In the non-setting mode, the LCD looks like this:

- ④① AF : Audio signal strength
- ④② RF : RF signal strength
- ④③ **A B** : Antenna A/B
- ④④  : Transmitter battery level
- ④⑤ G 88 / CH 88 : Frequency (group/channel)
- ④⑥ MUTE : Receiver mute
- ④⑦ ATT.ON : Output attenuation
- ④⑧ 888.888 MHz : Frequency

4-4 UHF PLL hand-held transmitter // **RŪ-850TH**

- 48 Power: push to turn the transmitter on. When the transmitter is on, push and hold for 2 seconds to turn it off.
- 49 Mute: while the transmitter is on, switch Mute up to talk and down to mute. If the transmitter is off, switch the Mute up to turn the unit on. The transmitter turns itself off automatically after 1, 10 or 30 minutes of muting depending on setting.
- 50 Ultrasonic receiving unit: it receives remoteset signal from the ultrasonic transmission unit at the receiver end.
- 51 Battery holder: it holds UM3, AA 1.5V battery or rechargeable battery x 2.
- 52 LED indicator: it shows the transmitter's status, including battery level, mute and pairing status.
- 53 Detachable capsule module.

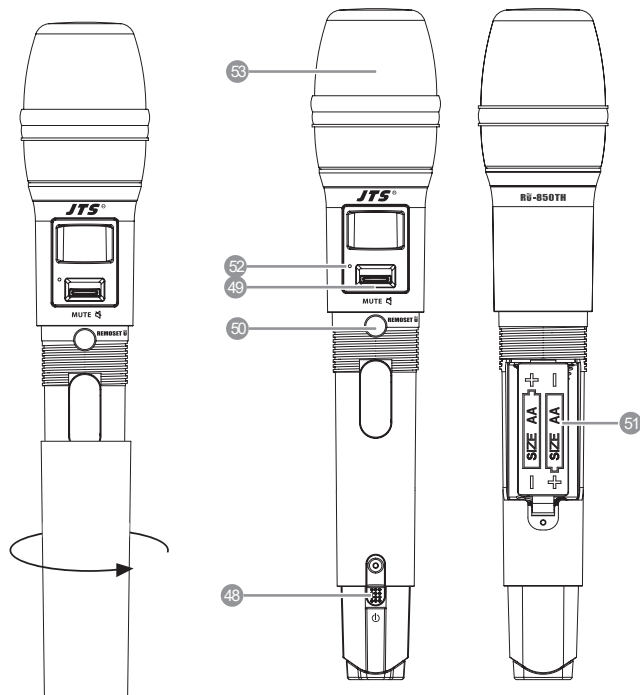

4-5 UHF PLL hand-held transmitter // **RÜ-850LTH**

- 54 Power: push to turn the transmitter on. When the transmitter is on, push and hold for 2 seconds to turn it off.
- 55 Mute: while the transmitter is on, switch Mute up to talk and down to mute. If the transmitter is off, switch the Mute up to turn the unit on. The transmitter turns itself off automatically after 1, 10 or 30 minutes of muting depending on setting.
- 56 Ultrasonic receiving unit: it receives pairing signals from the ultrasonic transmission unit at the receiver end.
- 57 Battery holder: it holds UM3, AA 1.5V battery or rechargeable battery x 2.
- 58 LED indicator: it shows the transmitter's status, including battery level, mute and pairing indication.
- 59 LCD display: it shows the parameter settings in the transmitter.
- 60 SET: it allows parameter settings, including frequency, group, channel, sensitivity, transmission power, auto off countdown and machine code.
- 61 ▲/▼: these are used with "SET" to change the parameter settings.
- 62 →: push and hold the "LOCK" button for 2 seconds to lock the buttons. Push and hold again for 2 seconds to unlock.
- 63 Charging contact: if rechargeable batteries are used, this microphone can be recharged with an optional charger.

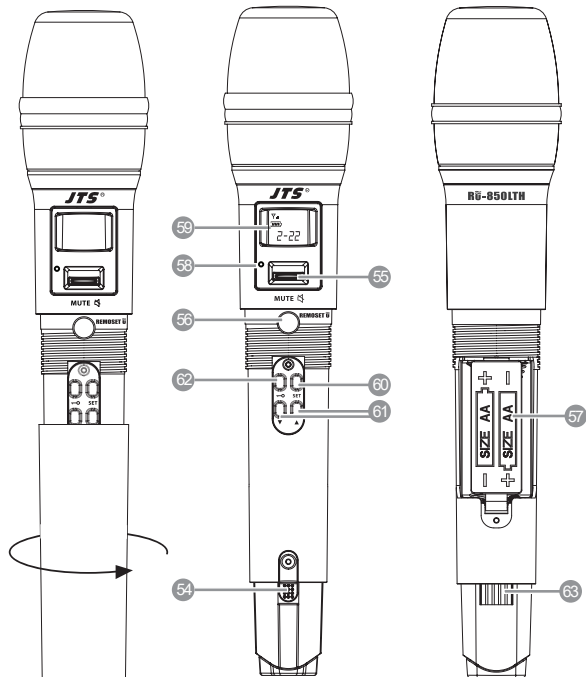

4-6 UHF PLL body-pack transmitter // **RŮ-850TB**

- 64 Mute/Power: push once to turn the unit on. While the unit is on, push once to mute and push again to talk. Push and hold for 2 seconds to turn off.
- 65 Ultrasonic receiving unit: it receives the pairing signals from the ultrasonic transmission unit at the receiver end.
- 66 LED indicator: it shows the transmitter's status, including battery level, mute and pairing indication.
- 67 Antenna: the antenna of transmitter
- 68 Microphone input port: 4P mini XLR jack
- 69 Battery holder: it holds UM3, AA 1.5V battery or rechargeable battery x 2.

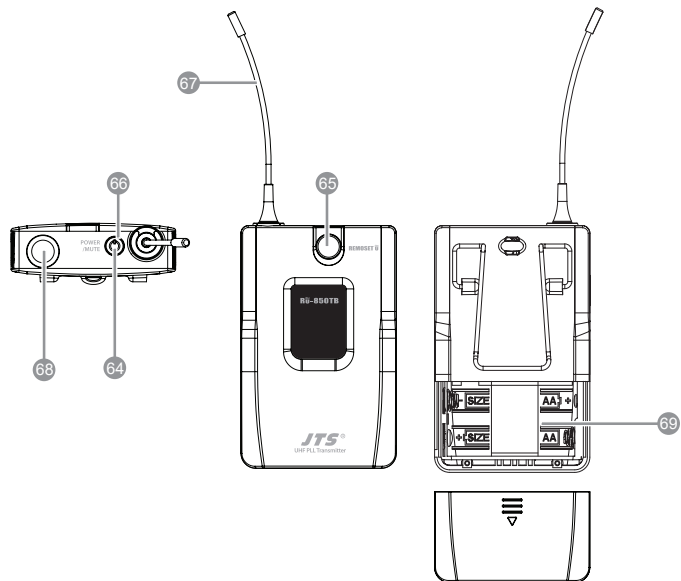

4-7 UHF PLL body-pack transmitter // **RŨ-850LTB**

- 70 Mute/Power: push once to turn the unit on. While the unit is on, push once to mute and push again to talk. Push and hold for 2 seconds to turn off.
- 71 Ultrasonic receiving unit: it receives the pairing signals from the ultrasonic transmission unit at the receiver end.
- 72 LED indicator: it shows the transmitter's status, including battery level, mute and pairing indication.
- 73 LCD display: it shows the parameter settings in the transmitter.
- 74 Antenna: the antenna of transmitter
- 75 Microphone input port: 4P mini XLR jack
- 76 SET: it allows parameter settings, including frequency, group, channel, sensitivity, input signal attenuation, auto off countdown, lock on and machine code.
- 77 ▲/▼: these are used with "SET" to change the parameter settings.
- 78 Battery holder: it holds UM3, AA 1.5V battery or rechargeable battery x 2.
- 79 Charging contact: if rechargeable batteries are used, this transmitter can be recharged with an optional charger.

Note: a user can also choose Auto power off with **RŨ-850LTB**

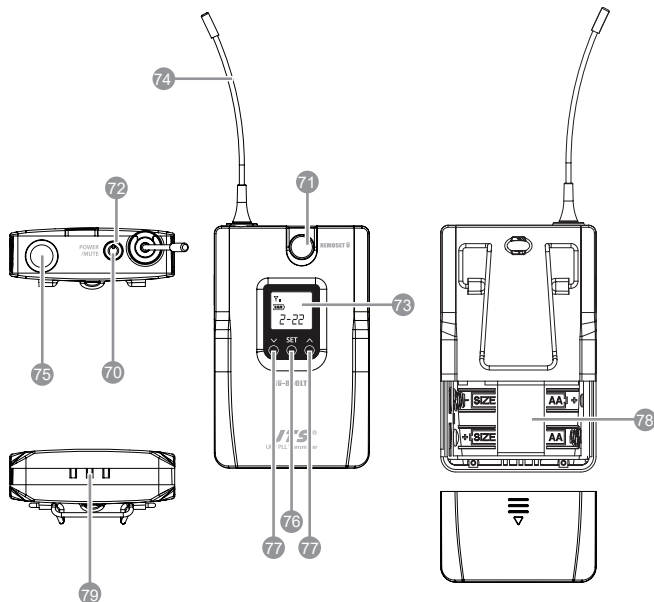

4-8 Accessories

80 AC/DC adaptor

Switching Power Supply(100V~240V , 50~60Hz)

AC IN: AC100~240V/50~60Hz

DC OUT: DC12V/0.5A Option

81 AF output cable (with $\Phi 6.3$ plug at both ends)

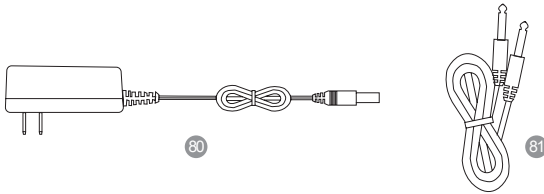

4-9 Optional Condenser Microphone

Lavalier Microphone // CM-501 CM-201i CM-125i

82 Clip

83 4 Pin Mini XLR

84 Windscreen

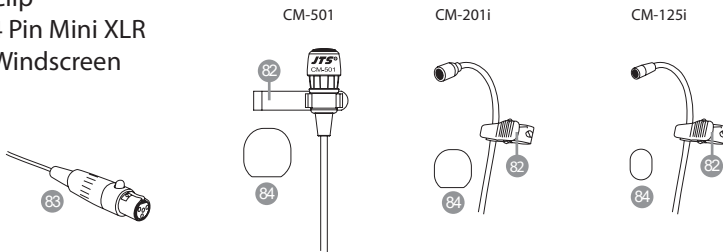

Headset Microphone // CM-214i CM-214Ui CM-214ULi CM-235i CX-504

- 85 Gooseneck
- 86 Adjustable headband
- 87 Headband
- 88 4 Pin Mini XLR
- 89 Windscreen

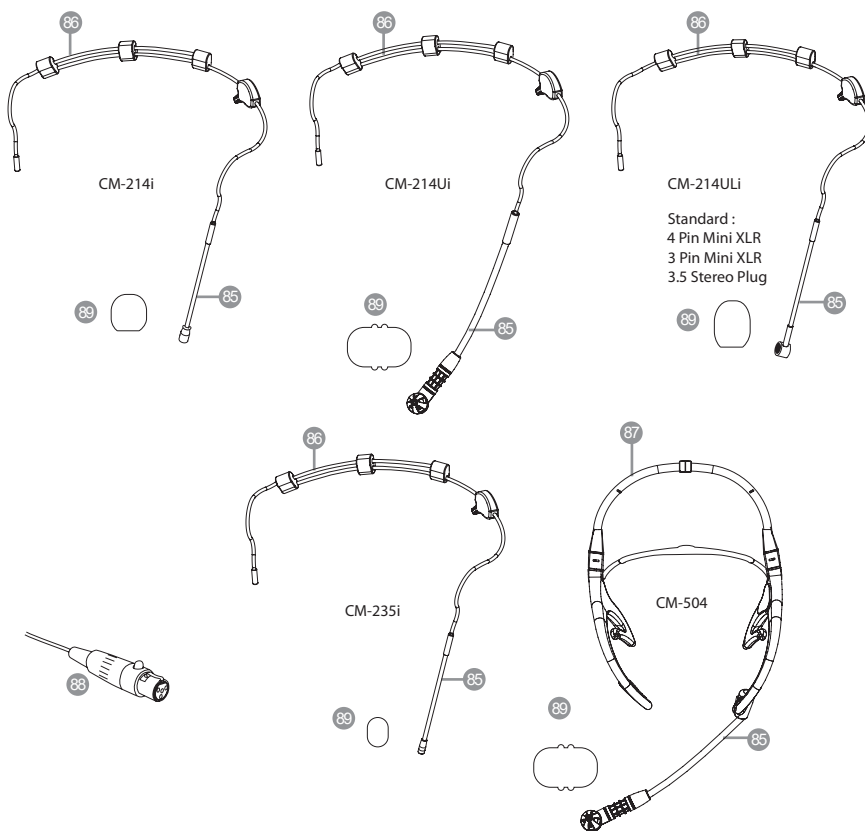

Ear-hook Microphone // CM-801 CM-804i CM-8015 CM-825i

- 90 Boom
- 91 Adjustable Headband
- 92 Adjustable ear hook
- 93 Detchable Cable
- 94 Cable Clip
- 95 Windscreen
- 96 4 Pin Mini XLR
- 97 3 Pin Mini XLR Option
- 98 3.5 Stereo Plug Option
- 99 4Pin Hirose connector Option

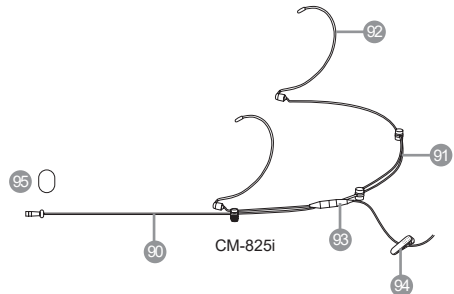
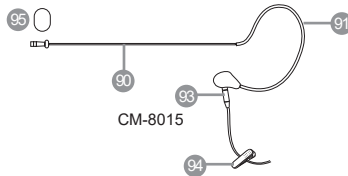
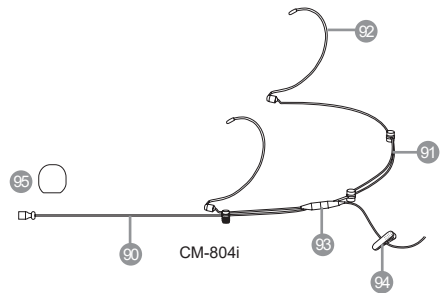
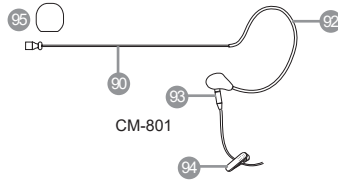
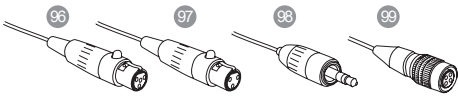

5. Connecting

5-1 How to connect the receiver

1. Connect the audio output of receiver to mixer or amplifier

1.1 **Rũ-8011D / Rũ-8011DB**

The XLR output jack or 6.3mm unbalance output jack can be selected to connect the AF output to a mixer or amplifier.

1.2 **Rũ-8012DB**

(1) The XLR output jack or 6.3mm unbalance output jack can be selected individually to connect the AF output to a mixer or amplifier for volume control.

(2) Switch the "Mixed" on the back to ON. This allows to mix the RX1 and RX2 signals to RX1's 6.3mm non-balance output jack and then to a mixer or amplifier for volume control.

2. Connect the power

2.1. Connect the AC/DC adapter:

Check that the DC current and voltage ratings of the adapter match the label on the unit. Connect the DC terminal to the "DC input" port on the unit, and the AC end to an AC socket.

2.2. Set the parameters:

Turn the power on and set the parameters of receiver according to the setting instructions.



Caution! Secure the power cable on the fastening hook of anti-pulling clip in order to prevent the power cable from falling.

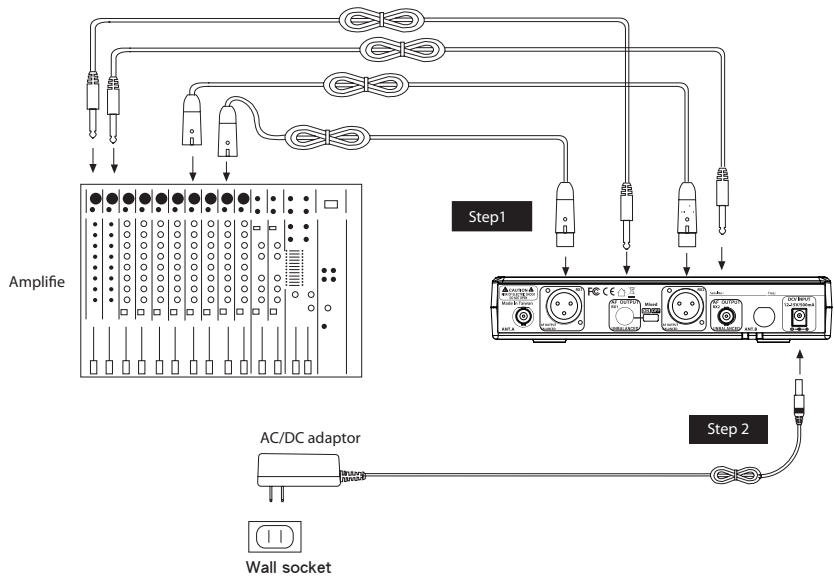

5-2 Transmitter installation //

Rũ-850TH / Rũ-850LTH/ Rũ-850TB Rũ-850LTB

The Mute button on the hand-held unit also triggers the power-on. That's why the unit is on as soon as the batteries are replaced. Therefore, if you do not wish to turn on after changing the batteries, keep the Mute switch on mute.

1. Unscrew the outer tube of the transmitter (Figure 1).
2. Place 2 AA batteries in the battery holder while make sure they are in the correct polarities (Figure 2).
3. Screw the outer tube on (Figure 3).
4. To turn the unit on:
 - a. Push the power button to turn on (Figure 4a), or
 - b. Push the Mute switch up also to turn the unit on (Figure 4b).
5. Set the transmitter parameters according to the instructions.

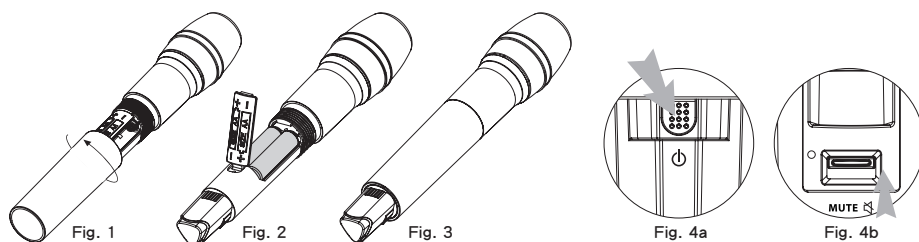

Rũ-850TB Rũ-850LTB

1. Slide the battery holder cover downwards (Figure 1).
2. Place 2 AA batteries in the battery holder while make sure they are in the correct polarities (Figure 2).
3. Slide the battery holder cover upwards to close (Figure 3)
4. According to the type of microphone, insert the 4-pin mini XLR jack in MIC IN to complete the installation (Figure 4).
5. Push the Power button to turn the unit on (Figure 5).
6. Set the transmitter parameters according to the instructions.

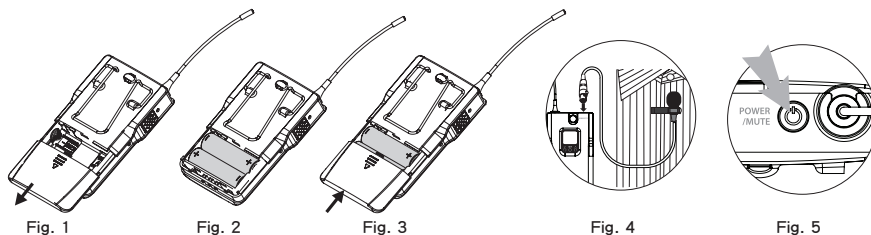

6. Instructions for use

6-1 How to use // **Rũ-8011D**

Parameter setting

Push and hold the “SET” button to enter the setting mode.

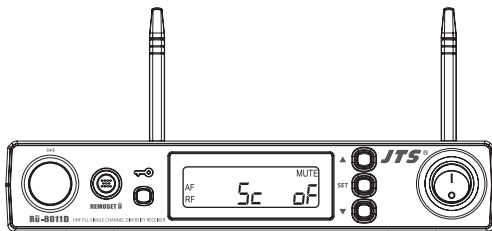

⊙ Group / channel setting

G: group	Select default group 1~6
CH : channel	Select default channel, 1~22 max



Select the group when “G” is flashing; select the channel when “CH” is flashing.

⊙ Channel scan

SC of	This means the function is deactivated.
SC on	This means the function is activated. (scan to make sure this channel is occupied or not)The program will avoid it automatically to prevent interference.



This function is deactivated.

⊙ Audio output attenuation (XLR)

At of	No attenuation at audio output
At on	20dB attenuation at audio output



This function is deactivated.

⊙ SQ receiving sensitivity

-5~+10dB; select SQ with ▲/▼	-5 is the maximum sensitivity.
	+10 is the minimum sensitivity.
The default setting is 0.	



The default setting is 0.

⊙ Microphone input sensitivity

Normal sensitivity	SE A : +15dB SE 9 : +12 dB SE 8 : +9dB SE 7 : +6dB SE 6 : +3 dB SE 5 : 0 dB SE 4 : -3 dB SE 3 : -6 dB SE 2 : -9 dB SE 1 : -12 dB SE 0 : -15 dB
20dB attenuation (body pack transmitter only)	SE AA : -5 dB SE A9 : -8 dB SE A8 : -11dB SE A7 : -14dB SE A6 : -17dB SE A5 : -20dB SE A4 : -23dB SE A3 : -26dB SE A2 : -29dB SE A1 : -32dB SE A0 : -35dB



Normal default sensitivity



20dB attenuation

⊙ ATOF: Automatic microphone off countdown under mute status

AO OF	This function is deactivated
AO 1	1 minute countdown to turn off
AO 10	10 minute countdown to turn off
AO 30	30 minute countdown to turn off

(The default setting is 10 minute.)



This function is deactivated.

⊙ RFP: RF microphone power

The transmitter comes with 2 stages of RF power output.

rF Lo	10mW
rF Hi	50mW



This shows that the RF output is LOW (10mW).

⊙ RC (Remoset Configuration)

rC Fr	Only frequency and group setting will be synchronized
rC AL	All data setting will be synchronized

The default setting is rC Fr.

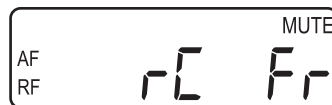

Only frequency and group setting will be synchronized.

Volume adjustment

In non-setting mode, adjust the volume from 0 to -31dB using the▲/▼button.

- The minimum volume is 0 (-31dB).
- The maximum volume is 31(0dB).
- The default volume setting is 21(-10dB).



Minimum volume at 0(-31dB); maximum volume at 31(0dB).

Volume	0	1	2	3	...	21	...	31
dB	-31	-30	-29	-28	...	-10	...	0

Pairing **REMOSET**

Once the parameters are set, push the “ **REMOSET**  ” button and the digital pairing data will be sent to the transmitter via ultrasonic transmitter for parameter synchronization. The indicator will flash rapidly while the data are being transmitted. When the synchronization is completed, the receiver will receive the corresponding data and the indicator will stop flashing. If the signal is not received for a certain period of time, the indicator will flash slowly to inform pairing failure (the slowly flashing indicator can be reset by pushing any button).

Note: The best pairing distance is 30cm, $\pm 30^\circ$.

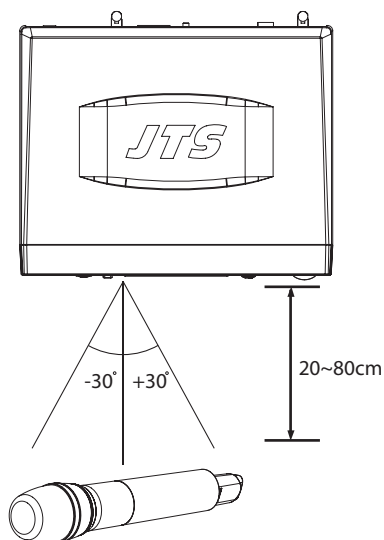

6-2 How to use // **RŪ-8011DB**

Parameter setting

Push and hold the “SET” button to enter the setting mode. Push the ▲/▼ button to choose to set RX (receiver) or TX (transmitter).

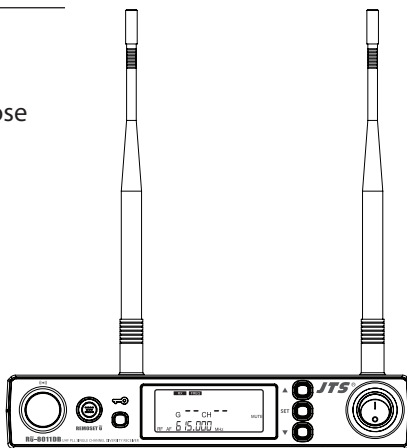

When RX receiver is selected:

◎ FREQ: frequency setting

In 1MHz	Select frequency with ▲/▼
In 0.025MHz	Select frequency with ▲/▼



Select the number of frequency first in MHz and then in 0.025MHz.

◎ Group / channel

G: group	Select default group 1~6
CH: channel	Select default channel, 1~22 max

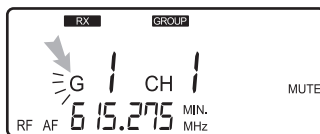

Select the group when “G” is flashing; select the channel when “CH” is flashing.

◎ Channel scan

SC off	This means the function is deactivated.
SC on	This means the function is activated. (scan to make sure this channel is occupied or not) The program will avoid it automatically to prevent interference.



This function is deactivated.

Note: this function works only in the preset mode.

⊙ Audio output attenuation (XLR)

At off	No attenuation at audio output
At on	20dB attenuation at audio output



This function is deactivated.

⊙ SQ Receiving sensitivity

-5~+10dB; select SQ with ▲/▼	-5 is the maximum sensitivity.
	+10 is the minimum sensitivity.
	The default setting is 0.



The default setting is 0.

When TX transmitter is selected:

⊙ ATT microphone audio input attenuation

At off	No attenuation at audio input
At on	20dB attenuation at audio input (depending on whether the transmitter is provided with the corresponding function).

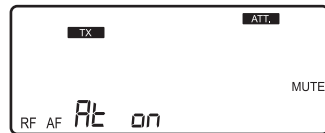

The function is activated with 20dB of audio input attenuation.

⊙ Microphone input sensitivity

Normal sensitivity	GAIN : +15dB
	GAIN : +12dB
	GAIN : +9dB
	GAIN : +6dB
	GAIN : +3dB
	GAIN : 0dB
	GAIN : -3dB
	GAIN : -6dB
	GAIN : -9dB
	GAIN : -12dB
GAIN : -15dB	



It shows the microphone input sensitivity is now at 0dB (default setting).

⊙ ATOF: Automatic microphone off countdown under mute status

AO OF	This function is deactivated
AO 1	1 minute countdown to turn off
AO 10	10 minute countdown to turn off
AO 30	30 minute countdown to turn off

(The default setting is 10 minute.)



This function is deactivated.

⊙ RFP: RF microphone power

The transmitter comes with 2 stages of RF power output (as per local regulations).

rF Lo	10mW
rF Hi	50mW

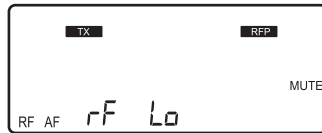

This shows that the RF output is LOW (10mW)

⊙ RC (Remoset Configuration)

rC-FrE	Only frequency and group setting will be synchronized
rC-ALL	All data setting will be synchronized

The default setting is rC-FrE.

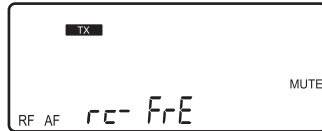

Only frequency and group setting will be synchronized.

Volume adjustment

In non-setting mode, adjust the volume from 0 to -31dB using the ▲/▼ button.

- The minimum volume is -31 dB.
- The maximum volume is 0 dB.
- The default setting is -10 dB.



Minimum volume at -31db; maximum volume at 0db

Pairing **REMOSET**

See page 26.

6-3 How to use // **Rũ-8012DB**

Parameter setting

Push and hold the “SET” button to enter the setting mode. Push the ▲/▼ button to choose to set RX (receiver) or TX (transmitter).

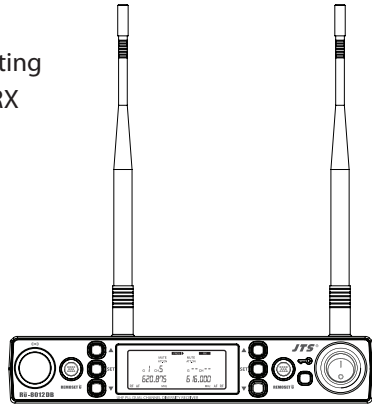

When RX receiver is selected:

◎ **FREQ:** frequency setting

In 1MHz	Select frequency with ▲/▼
In 0.025MHz	Select frequency with ▲/▼

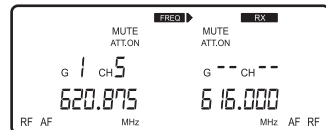

Select the number of frequency first in MHz and then in 0.025MHz.

◎ **Group / channel**

G: group	Select default group 1~6
CH: channel	Select default channel, 1~22 max

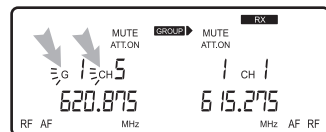

Select the group when “G” is flashing; select the channel when “CH” is flashing.

◎ **Channel scan**

SC off	This means the function is deactivated.
SC on	This means the function is activated (scan to make sure this channel is occupied or not. The program will avoid it automatically to prevent interference.

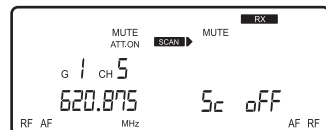

This function is deactivated.

Note: this function works only in the preset mode.

◎ Audio output attenuation (XLR)

At off	No attenuation at audio input
At on	20dB attenuation at audio input (depending on whether the transmitter is provided with the corresponding function) .

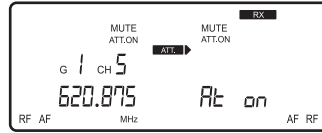

The function is activated with 20dB of audio input attenuation.

◎ SQ Receiving sensitivity

-5~+10dB; select SQ with ▲/▼	-5 is the maximum sensitivity.
	+10 is the minimum sensitivity.
	The default setting is 0.

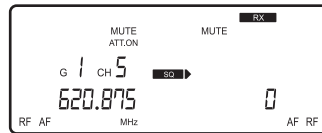

It shows the SQ is 0dB (default setting).

When TX transmitter is selected:

◎ ATT microphone audio input attenuation

At off	No attenuation at audio input
At on	20dB attenuation at audio input

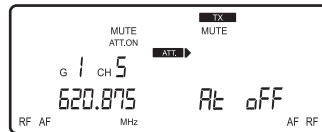

This function is deactivated.

◎ Microphone input sensitivity

Normal sensitivity	GAIN : +15dB
	GAIN : +12dB
	GAIN : +9dB
	GAIN : +6dB
	GAIN : +3dB
	GAIN : 0dB
	GAIN : -3dB
	GAIN : -6dB
	GAIN : -9dB
	GAIN : -12dB
GAIN : -15dB	

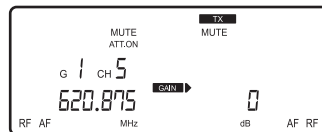

It shows the microphone input sensitivity is now at 0dB (default setting).

⊙ ATOF: Automatic microphone off countdown under mute status

OFF	This function is deactivated
1	1 minute countdown to turn off
10	10 minute countdown to turn off
30	30 minute countdown to turn off

(The default setting is 10 minute.)

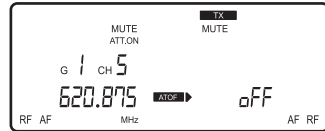

This function is deactivated.

⊙ RFP: RF microphone power

The transmitter comes with 2 stages of power output (as per local regulations).

rF Lo	10mW
rF Hi	50mW

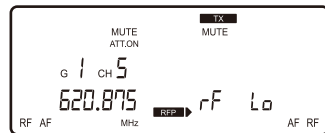

This shows that the RF output is LOW (10mW).

⊙ RC (Remoset Configuration)

rC-FrE	Only frequency and group setting will be synchronized
rC-ALL	All data setting will be synchronized

The default setting is rC-FrE.

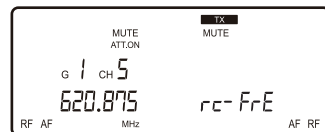

Only frequency and group setting will be synchronized.

Volume adjustment

In non-setting mode, adjust the volume from 0 to -31dB using the ▲/▼ button.

- The minimum volume is -31 dB.
- The maximum volume is 0 dB.
- The default setting is -10 dB.

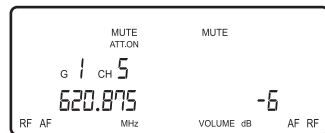

Minimum volume at -31db; maximum volume at 0db

Pairing REMOSET

See page 26.

Others

The transmitter's battery level is also shown on the LCD display. If the battery level is ≤ 2V, the frame around the battery level will flash and the backlight turns into red as a warning (for **R**-8011DB and **R**-8012DB).

6-4 How to use // **RŨ-850TH / RŨ-850TB**

Parameter setting

Parameters, including group, channel, microphone input sensitivity, auto off countdown and RF power, are set at the receiver end and synchronized via **REMOSET ũ**.

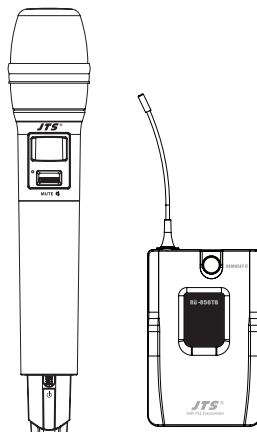

Pairing **REMOSET ũ**

See page 26.

Indicators

Green	Battery > 2V
Flashing green	Microphone mute
Red	Battery ≤ 2V
Alternating red and green	Microphone mute (and battery low)
Blue	Pairing successful
Flashing blue	Data receiving error

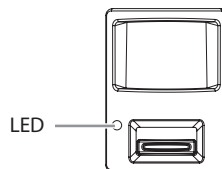

Others

- When the battery level is <1.8V, the transmitter will turn itself off automatically.
- When **RŨ-850TB** is on, push the mute/power button to mute the transmitter and push again to talk. Push and hold for 2 seconds to turn off.

6-5 How to use // **RŨ-850LTH/ RŨ-850LTB**

Parameter setting

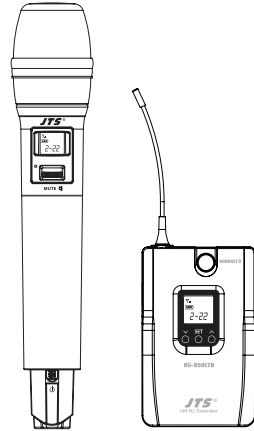

◎ **FREQ:** frequency setting

In 1MHz	Select frequency with ▲/▼
In 0.025MHz	Select frequency with ▲/▼

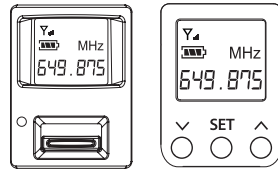

Select the number of frequency first in MHz and then in 0.025MHz.

◎ **Group / channel**

G: group	Select default group 1~6
CH: channel	Select default channel, 1~22 maxSelect default channel, 1~22 max

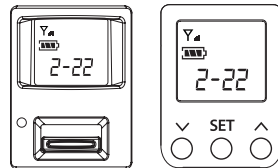

Select the number for group and then the number for channel.

◎ **ATT microphone audio input attenuation**

Att oFF	No attenuation at audio input
Att on	20dB attenuation at audio input

Only for PT-850L

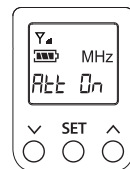

It shows the audio input attenuation at 20dB.

⊙ Microphone input sensitivity

Normal sensitivity	GAIN : +15dB
	GAIN : +12dB
	GAIN : +9dB
	GAIN : +6dB
	GAIN : +3dB
	GAIN : 0dB
	GAIN : -3dB
	GAIN : -6dB
	GAIN : -9dB
	GAIN : -12dB
	GAIN : -15dB

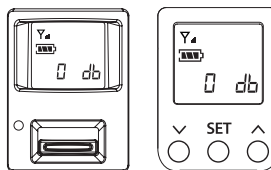

It shows the sensitivity is now at GAIN 0dB (default setting).

⊙ RFP: RF microphone power

rFP Lo	10mW
rFP Hi	50mW

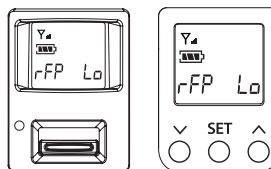

The RF output is LOW.

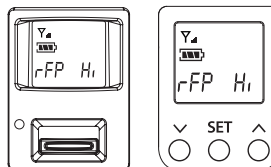

The RF output is Hi.

⊙ AUTO-OFF: Automatic microphone off countdown under mute status

OFF	This function is deactivated
1	1 minute countdown to turn off
10	10 minute countdown to turn off
30	30 minute countdown to turn off

(The default setting is 10 minute.)

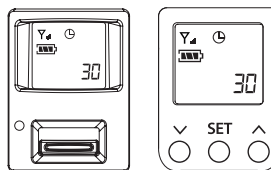

⊙ Key Lock

Loc on	Lock ON
Loc off	Lock OFF

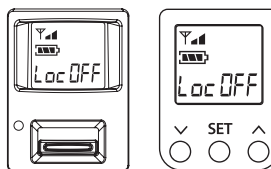
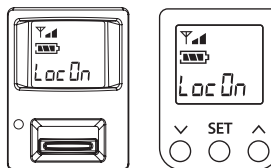

7. Notes for the product

- (1) For the best signal receiving quality, always keep the receiver within 3m of the transmitter.
- (2) The receiver and transmitter shall be away from other metal objects, preferably 50cm or farther.
- (3) Do not point the microphone directly to a speaker, or there will be feedbacks.
It is recommended to hold the transmitter (microphone) at the middle section for the best pickup.
- (4) In case that the transmitter will not be in use for an extended period of time, the batteries shall be removed from the battery holder to prevent damage to the transmitter due to leak of battery electrolyte solution.
- (5) For the best power performance, it is recommended to change both batteries or use the products of the same manufacturer when they are to be changed.