

RACER250

USER GUIDE

H11661/H11662 - Version 1 / 04-2024

1 - Safety information

Important safety information



This unit is intended for indoor use only. Do not use it in a wet, or extremely cold/hot locations. Failure to follow these safety instructions could result in fire, electric shock, injury, or damage to this product or other property.



Any maintenance procedure must be performed by a CONTEST authorised technical service. Basic cleaning operations must thoroughly follow our safety instructions.



This product contains non-isolated electrical components. Do not undertake any maintenance operation when it is switched on as it may result in electric shock.

Symbols used



This symbol signals an important safety precaution.



The WARNING symbol signals a risk to the user's physical integrity. The product may also be damaged.



The CAUTION symbol signals a risk of product deterioration.

Instructions and recommendations

1 - Please read carefully :

We strongly recommend to read carefully and understand the safety instructions before attempting to operate this unit.

2 - Please keep this manual :

We strongly recommend to keep this manual with the unit for future reference.

3 - Operate carefully this product :

We strongly recommend to take into consideration every safety instruction.

4 - Follow the instructions:

Please carefully follow each safety instruction to avoid any physical harm or property damage.

5 - Avoid water and wet locations :

Do not use this product in rain, or near washbasins or other wet locations.

6 - Installation :

We strongly encourage you to only use a fixation system or support recommended by the manufacturer or supplied with this product. Carefully follow the installation instructions and use the adequate tools.

Always ensure this unit is firmly fixed to avoid vibration and slipping while operating as it may result in physical injury.

7 - Ceiling or wall installation :

Please contact your local dealer before attempting any ceiling or wall installation.

8 - Ventilation :

The cooling vents ensure a safe use of this product, and avoid any overheating risk. Do not obstruct or cover these vents as it may result in overheating and potential physical injury or product damage. This product should never be operated in a closed non-ventilated area such as a flight case or a rack, unless cooling vents are provided for the purpose.

9 - Heat exposure :

Sustained contact or proximity with warm surfaces may cause overheating and product damages. Please keep this product away from any heat source such as a heaters, amplifiers, hot plates, etc...

CAUTION
RISK OF ELECTRIC SHOCK
DO NOT OPEN

WARNING : This unit contains no user-serviceable parts. Do not open the housing or attempt any maintenance by yourself. In the unlikely even your unit may require service, please contact your nearest dealer.
In order to avoid any electrical malfunction, please do not use any multi-socket, power cord extension or connecting system without making sure they are perfectly isolated and present no defect.

Sound levels

Our audio solutions deliver important sound pressure levels (SPL) that can be harmful to human health when exposed during long periods. Please do not stay in close proximity of operating speakers.

Recycling your device

- As HITMUSIC is really involved in the environmental cause, we only commercialise clean, ROHS compliant products.
- When this product reaches its end of life, take it to a collection point designated by local authorities. The separate collection and recycling of your product at the time of disposal will help conserve natural resources and ensure that it is recycled in a manner that protects human health and the environment.

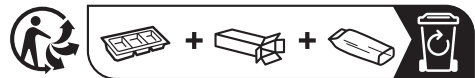

10 - Electric power supply :

This product can only be operated according to a very specific voltage. These information are specified on the label located at the rear of the product.

11 - Power cords protection:

Power-supply cords should be routed so that they are not likely to be walked on or pinched by items placed upon or against them, paying particular attention to cords at lugs, convenience receptacles and the point where they exit from the fixture.

12 - Cleaning precautions :

Unplug the product before attempting any cleaning operation. This product should be cleaned only with accessories recommended by the manufacturer. Use a damp cloth to clean the surface. Do not wash this product.

13 - Long periods of non use :

Disconnect the unit's main power during long periods of non use.

14 - Liquids or objects penetration :

Do not let any object penetrate this product as it may result in electric shock or fire. Never spill any liquid on this product as it may infiltrate the electronic components and result in electric shock or fire.

15 - This product should be serviced when :

Please contact the qualified service personnel if :

- The power cord or the plug has been damaged.
- Objects have fallen or liquid has been spilled into the appliance.
- The appliance has been exposed to rain or water.
- The product does not appear to operate normally.
- The product has been damaged.

16 - Inspection/maintenance :

Please do not attempt any inspection or maintenance by yourself. Refer all servicing to qualified personnel.

17 - Operating environment :

Ambient temperature and humidity: +5 - +35°C, relative humidity must be less than 85% (when cooling vents are not obstructed).

Do not operate this product in a non-ventilated, very humid or warm place.

2 - Introduction

Thank you for choosing the RACER250 amplified system.

- An easy-to-carry all-in-one system
- Performance and sound quality
- Built-in media player
- One UHF diversity receiver
- One UHF diversity receiver slot

The RACER250 is a powerful all-in-one system with excellent sound quality for all your on-the-go performances.

It comes standard with a USB/SD player, Bluetooth® TWS receiver and a mixer for connecting two additional microphones and an external source. It's easy to carry with its built-in trolley, and it has excellent battery life and can be charged while in use. With its integrated compartment that can accommodate two microphones, it is easy to store in a minimum of space.

For its protection you can add a cover (code: H10791).

- Visualization of the battery level by LED display
- Simultaneous charging and use
- Automatic cut-off in case of low battery level
- Storage compartment for two microphones and cables
- Retractable handle and transport wheels

3 - The different modules

Back

A - UHF receiver module.

B - Optional UHF receiver module.
See paragraph 5 for more details.

C - USB/SD/Bluetooth® TWS module assigned to channel 1

D - Mixer section.

E - Master section

F - Power supply section

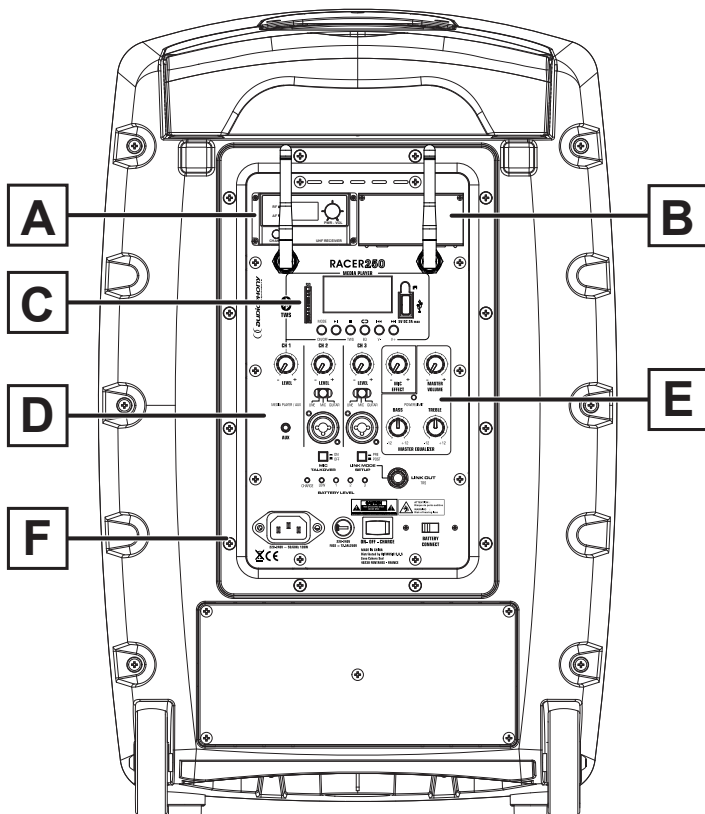

Top

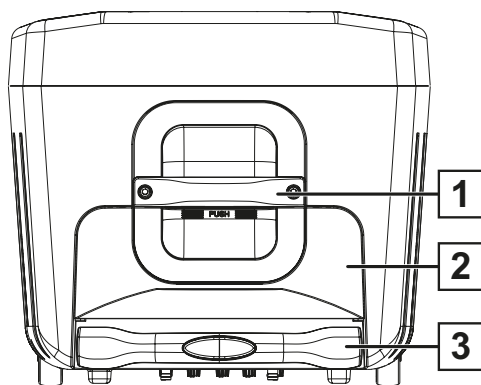

- 1 - Fixed carrying handle
- 2 - Accessories storage compartment
- 3 - Telescopic carrying handle

4 - Description of modules

4 - 1 : USB/SD/Bluetooth® TWS module

1 - SD card slot

2 - Player display

3 - IR diode for receiving remote control signals

4 - USB mass storage port for USB key. This USB plug can also be used to recharge a phone or a tablet: DC 5 V 2 A



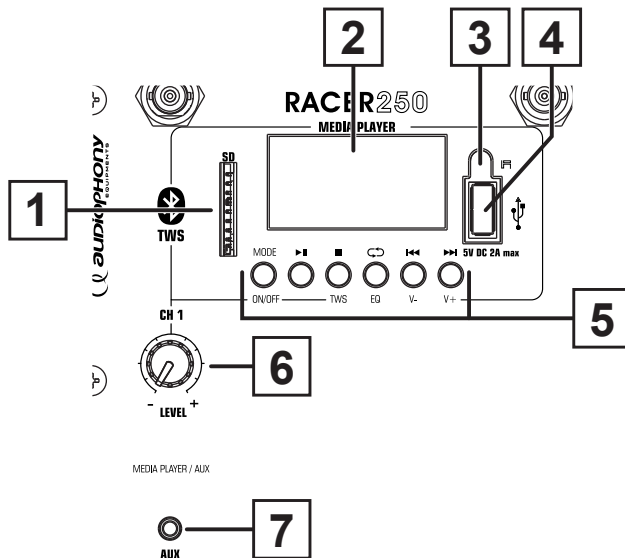

5 - Multimedia player controls

6 - Level control: This control is for the multimedia player and the AUX input level

7 - AUX input on 3.5 stereo jack. Priority AUX input on the player as soon as a source is connected.



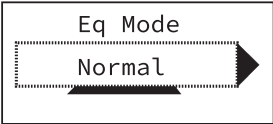
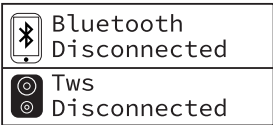
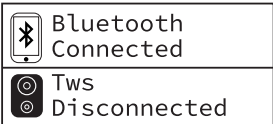
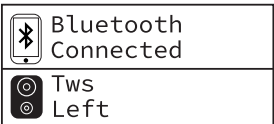
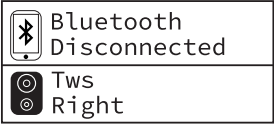
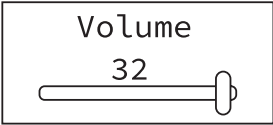

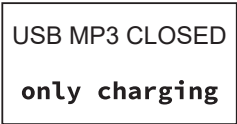
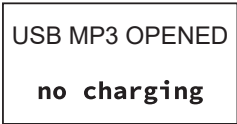







Action	Display
<p>Switch the player on and off:</p> <p>Long press on the MODE button</p> <p>The player starts up.</p> <p>When the RACER is turned on, the player turns on automatically.</p>	
<p>If no USB or SD media is connected to the player.</p>	
<p>Connecting a USB or SD media :</p> <p>If you connect a USB or SD media containing music tracks, they will be detected automatically. The player automatically switches to stop mode. Press ▶ to start playback.</p>	

Action	Display	
<p>Selecting the repeat mode:</p> <p>Short press on .</p> <p>Different repeat modes are: Repeat All (A) / Repeat One (1) / Repeat Folder (F) / Random (R).</p>		
<p>Choice of equalization mode:</p> <p>Long presse on .</p> <p>Different equalization modes are : Normal / Rock / Pop / Classic / Jazz / Country.</p>		
<p>Switch to Bluetooth mode :</p> <p>Short press on MODE.</p>		
<p>Pairing :</p> <p>To pair your RACER250 switch to Bluetooth mode and the display will show «Bluetooth Disconnected». Now you need to pair a Bluetooth source. Turn on your Bluetooth source and perform a device search. Select «RACER» from the list and accept the connection.</p>		
<p>Activate the TWS mode (stereo reproduction with two RACER) :</p> <p>Switch both RACERs to Bluetooth mode. Long press the TWS button on the RACER that is playing the Bluetooth source. The RACERs will automatically switch to TWS mode.</p> <p>Note: The TWS mode works with all models in the RACER range (80 / 120 / 250)</p>	<p>RACER 1</p>	
	<p>RACER 2</p>	
<p>Setting the player level :</p> <p>Long press on V- or V+.</p>		
<p>Activate or deactivate the charger mode of the USB port :</p> <p>In SD and USB mode: Long press on .</p> <p>In BT mode: Short press on the key .</p> <p>When in charge mode, the USB port delivers up to 2 amps, the USB data is inactive and the SD port remains accessible.</p>		

Multimedia player mode displays



	Indicates musical mode.	
	Indicates the playback mode. To switch from one mode to another, use  key.	
0079 0144	The top line shows the number of the current song and the bottom line shows the total number of songs.	
POP 	Indicates the current equalization mode.	
	Indicates the type of file being played and its compression ratio.	
	Indicates the media being played.	
00:02:12/00:04:04	Indicates the time in the song playback / the total time of the song	
▶ FILENAME.MP4	Indicates the name of the song being played	
	Reading level bar graph	
Use  and  keys to switch from one song to another. Use  key to start or pause playback. Use  key to stop playback		

4 - 2 : Remote control

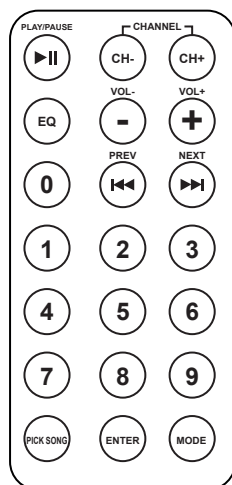

The infrared remote control of your player allows you to remotely control certain functions of your player for your SD/USB or Bluetooth® sources.

- The CH- and CH+ keys are used to move through the folders on the SD or USB media.
- The «EQ» button allows you to select different equalization presets according to different music genres: Normal / Rock / Pop / Classic / Jazz / Country.
- The Vol- and Vol+ keys are used to adjust the output level of the player.
- The «ENTER» key allows you to choose the playback mode: Repeat All (A)/ Repeat One (1)/ Repeat Folder (F)/ Random (R).
- The MODE button activates the Bluetooth® mode
- The 0 to 9 keys allow direct access to a song.

4 - 3 : Mixer section

1 - CH2 and CH3 inputs on XLR and 6.35 jacks. Allow to connect a microphone or an instrument.

2 - Input selector for channels 2-3. Selects the source on each channel.

3 - Potentiometers for adjusting the volume of the CH2 and CH3 channels.

4 - LINK OUT.

Allows you to feed the output signal back to another sound system (balanced signal)

5 - LINK MODE SETUP button.

- PRE: The signal is the sum of the signals present at the input. The output level does not depend on the MASTER volume.

- POST: The signal is the sum of the signals present at the input. The output level depends on the MASTER volume.

6 - MIC TALKOVER button.

Enables or disables the talkover function on the microphone channels including the HF microphone.

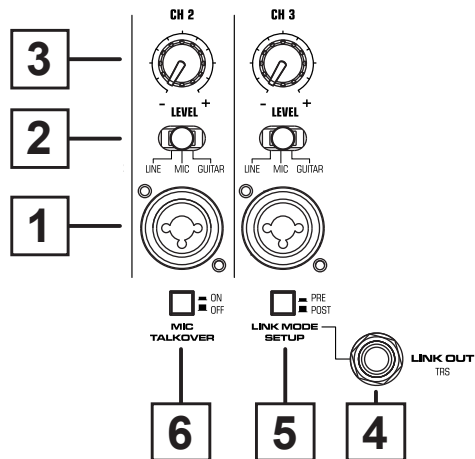

4 - 4 : Master section

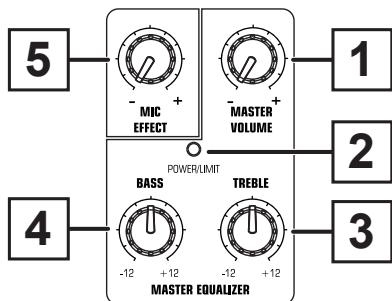

1 - MASTER volume control.

This control affects the overall output volume of the system.

2 - POWER/LIMIT light. Indicates whether the system is powered and whether the limiter is active.

When the light is blue, the system is powered up.

When the light is flashing red, it means that the power limiter protection system is active. Please lower the input level of your sources and/or the master.

3 - Potentiometer for adjusting the treble level.

From -12 dB to +12 dB clockwise. This adjustment affects the output of the master.

4 - Potentiometer for adjusting the bass level.

From -12 dB to +12 dB clockwise. This adjustment affects the output of the master.

5 - MIC EFFECT: Potentiometer to adjust the level of the effect applied to the microphone channels.

4 - 5 : Power supply section

1 - Mains plug.

Please plug in your power cord to recharge the batteries and/or use your device.

2 - Fuse holder.

Please replace the fuse with an identical model only. Fuse T3.15AL 250V.

3 - ON-OFF-CHARGE switch.

- In the ON position: The RACER250 is powered on.

- In the OFF position: The RACER250 is off.

- In the CHARGE position: The RACER250 batteries are charging. The BATTERY CONNECT switch must be in the ON position for charging to take place.

4 - BATTERY CONNECT switch.

Disconnects the battery when the RACER250 is not used for a long time.

This saves the batteries life.

The switch is set to OFF on delivery.

5 - Battery level indicators.

It is imperative to charge the batteries when only the LOW light is on.

The CHARGE indicator of the batteries lights up green when the batteries are charged.

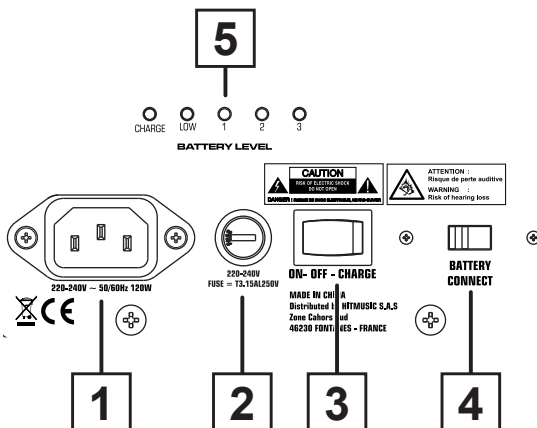

Precautions for using the integrated battery

- 1 - This device is equipped with two 18 V / 7 Ah batteries for an autonomy of 6 hours on average depending on the type of use.
- 2 - The batteries take about 8 hours to fully charge.
- 3 - A charge management system is built into the device and tells you when a recharge is needed.
- 4 - If, however, the battery level is low and only the «LOW» indicator is lit, connect your device to the mains or replace the batteries with charged ones.
- 5 - Used batteries must be disposed of in the appropriate waste disposal system. Do not dispose of them in the environment.
- 6 - **To conserve battery power, always turn the unit completely off and set the BATTERY CONNECT switch to the OFF position when not in use.**
- 7 - Batteries must be charged regularly to prevent them from drying out and becoming completely unusable. We recommend charging the batteries at least once every three months.
- 8 - The batteries in this unit are considered wear parts and are not covered by the warranty.

5 - Installation of optional UHF modules: RACER-GoMod (F5 or F8)

5 - 1 : A single module

Before handling, make sure that the RACER is switched off.

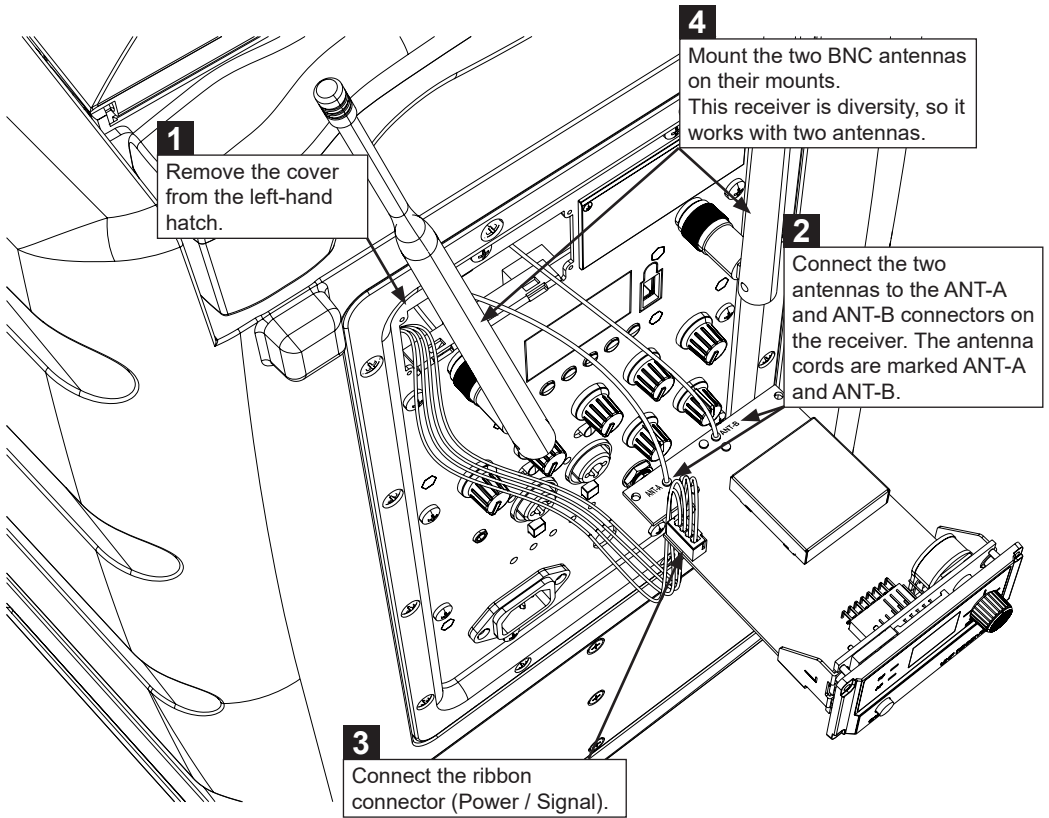



IMPORTANT

Do not forget to lock the cords in the jaws provided for this purpose.

Insulate the ends of the unused cords and hang them behind the trap door B

5 - 2 : Two modules

Before handling, make sure that the RACER is switched off.

1

Remove the two covers.

2

Connect the two antennas to the ANT-A and ANT-B connectors on receiver 1. The antenna cords are marked ANT-A and ANT-B.

3

Connect the LINK OUT-B output of receiver 1 to the LINK IN-B input of receiver 2. The cable is marked LINK-OUT B and LINK-IN B.

5

Connect the ribbon connector (Power / Signal).

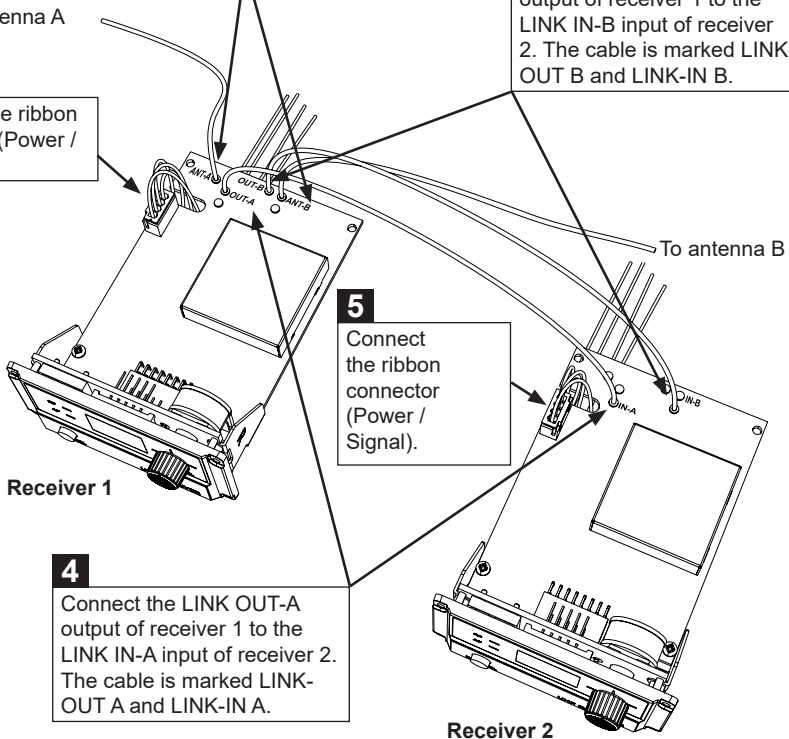

4

Connect the LINK OUT-A output of receiver 1 to the LINK IN-A input of receiver 2. The cable is marked LINK-OUT A and LINK-IN A.

5

Connect the ribbon connector (Power / Signal).

6

Mount the two BNC antennas on their mounts. These receivers are diversity, so they work with two antennas.



Do not forget to lock the cords in the jaws provided for this purpose.

6 - Technical data

Inputs	2 channels XLR/TRS combo Line/Mic input 1 1/8" AUX channel 1 Bluetooth connexion 2 optional UHF microphones			
Outputs	1 TRS jack output			
Loudspeaker	12" loudspeaker + 1.35" titanium driver, total impedance: 4 Ohms			
Power	250W RMS Class D amplifier			
Frequency response	60 - 20k Hz			
Sound pressure level	125 dB SPL max			
HF microphone (Option)	RACER-GoMod UHF diversity receiver	Receivers	Go emitters	Go microphones GO-Head Code : H9991 GO-Lava Code : H9992
		RACER-GoModF5 (F5 range) Code : H11411	GO-Hand-F5 Code : H11030 GO-Body-F5 Code : H11031	
		RACER-GoModF8 (F8 range) Code : H11410	GO-Hand-F8 Code : H9989 GO-Body-F8 Code : H9990	
Frequency range	F8 range : UHF 823~832 MHz and 863~865 Mhz - 10 mW F5 range : UHF 514~542 MHz - 35 mW			
Reader	Built-in USB key / SD card reader and Bluetooth® receiver Maximum capacity 32 Gb Supplied with an infrared remote control			
Bluetooth®	Type V5.0 AVRCP, with an excellent, close-to-digital audio transmission			
Settings and indicators	Independent level settings for each channel Low and treble equalizer from -12dB to + 12dB ROOM and talkover effects on all mic channels Power and Limit Indicator Battery charge indicators			
Finish	Polypropylene housing, metal mesh grill. C36 mounting plate for speaker stands			
Dimensions (in mm)	615 x 350 x 395			
Net weight (incl. batteries)	22.8 kg			
Batteries	2 x 18V / 7Ah wired in series / 150 x 95 x 97 mm			
Autonomy	6 hours depending on the volume			
Charging time	8 hours to recharge the two 18 V batteries			
Power management	LED display to indicate the charge level. Charge it and use it at the same time. Automatic shutdown if the battery level is too low.			
Option	Protective cover (code: H10791)			

Because AUDIOPHONY® takes the utmost care in its products to make sure you only get the best possible quality, our products are subjects to modifications without prior notice. That is why technical specifications and the products physical configuration might differ from the illustrations.

Make sure you get the latest news and updates about the AUDIOPHONY® products on www.audiophony.com
AUDIOPHONY® is a trademark of HITMUSIC S.A.S - 595 rue de la Pièce Grande - 46230 Fontanes - FRANCE