

DO iT

On a pensé à vous !



ORIGINE
FRANCE®
GARANTIE

BVCert. 6164725

ERARD®

FiXiT

Caractéristiques techniques

GARANTIE
10 ANS

FiXiT 200

- Support fixe pour écrans de 19" à 32"
- Testé jusqu'à 150 kg

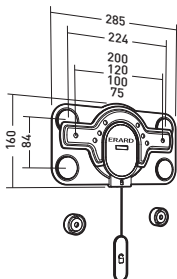
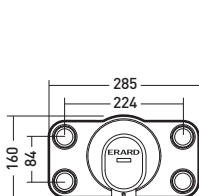

M 19"-32"
48-81 cm



50 KG



16 mm



VESA
75-200

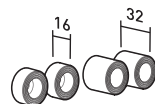

FiXiT 400

- Support fixe pour écrans de 30" à 55"
- Testé jusqu'à 200 kg

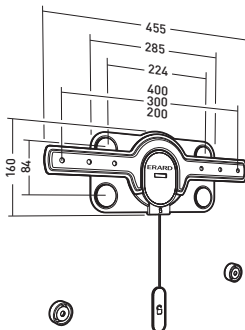
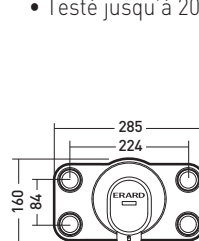

L 30"-55"
76-140 cm



60 KG



16 mm



VESA
200-400

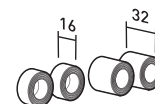

FiXiT 600

- Support fixe pour écrans de 40" à 75"
- Testé jusqu'à 280 kg

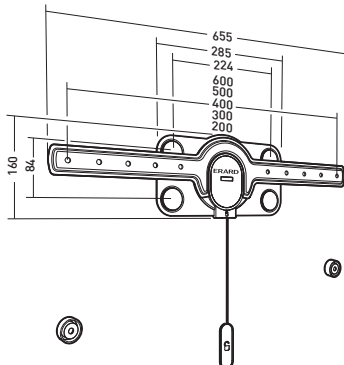
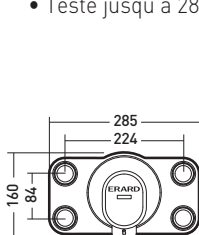

XL 40"-75"
102-190cm



70 KG



16 mm



VESA
200-600

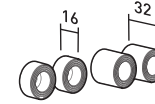

**GARANTIE
10 ANS**

TiLTiT / TWiSTiT

Caractéristiques techniques

TiLTiT 400

- Support inclinable pour écrans de 30" à 55"
- Testé jusqu'à 120 kg

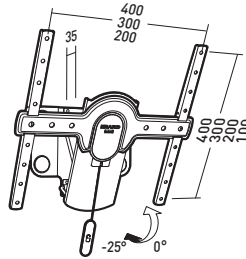
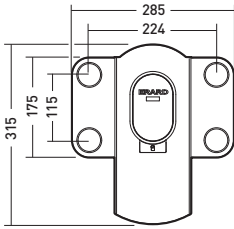

L 30"-55"
76-140 cm



30 KG



0 > 25°



VESA
200-400



35 mm



ÉPAISSEUR MAXI
50 mm

TWiSTiT 400

- Support inclinable et orientable pour écrans de 30" à 55"
- Testé jusqu'à 120 kg

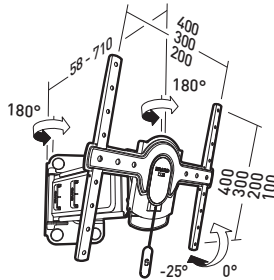
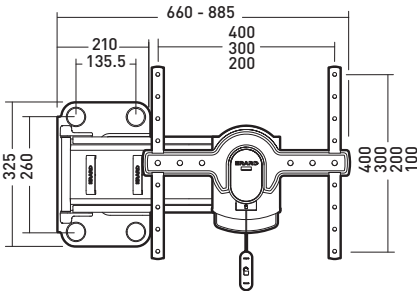

L 30"-55"
76-140 cm



30 KG



0 > 25°



VESA
200-400



-90 > +90°



58 mm



ÉPAISSEUR MAXI
50 mm

Bras télescopique
avec réglette
intégrée

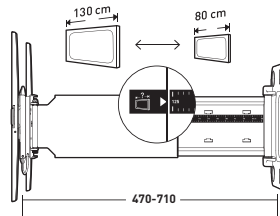

Bras télescopique



INSTALLATION EN
ANGLE POSSIBLE

Gamme DO iT

Gamme complète pour écrans plats

M 19"-32"
48-81cm

L 30"-55"
76-140cm

XL 40"-75"
102-190cm

19" 30" 32" 42" 55" 75"

TWISTIT 400
INCLINABLE
ET ORIENTABLE



044440

TILTIT 400
INCLINABLE



044240

FIXIT
FIXE



FIXIT 200



044020

FIXIT 400



044040

FIXIT 600



044060

ERARD®

ACCESSOIRES ESSENTIELS
POUR MATÉRIELS AUDIO VIDÉO

Mail : infos@erard.fr / www.erard.com / Tél : +33 (0)4 72 46 16 26 / Fax : +33 (0)4 72 46 16 22

N° intracommunautaire : FR 81 403 591 415
Z.I. de Chavanoz / 4 route de la Plaine / 38236 CHAVANOZ / FRANCE

