

Les APPLIK® pour écrans de grande taille sont disponibles en version fixe et fixe extra plat pour les VESA 600x400 ; fixe, fixe extra-plat et orientable-inclinable pour les VESA 800 x 400. Les versions SLIMs permettent un écartement très faible du mur de 16 mm pour un effet finesse de l'écran renforcé.

Les versions inclinables disposent d'un système anti-décrochement.

Enfin, les modèles fixes et orientables (réfs 45007, 45008, 2532) permettent un réglage en hauteur par 3 positions ; le modèle orientable permet en plus, un réglage de l'horizontalité de l'écran de +/- 4°.

Un niveau à bulle et un assortiment complet de visserie sont fournis avec les 5 modèles.

Ref. 045007

GENCOD 318528 045007 7

600X400



Ø 8 max

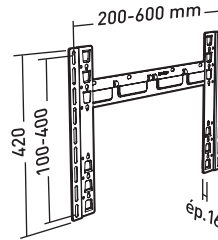
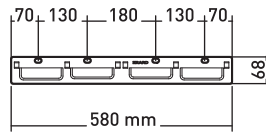

30° - 46°



70 KG



VESA 200 x 600x400



SLIM 16 mm

Ref. 045201

GENCOD 318528 045201 9



Ø 8 max

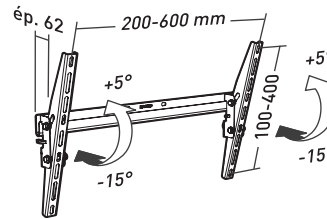
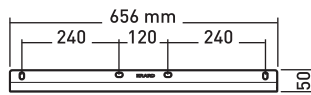

30° - 46°



70 KG



VESA 200 x 600x400



-15° / + 5°

Ref. 045008

GENCOD 318528 045008 4

800X400



Ø 8 max

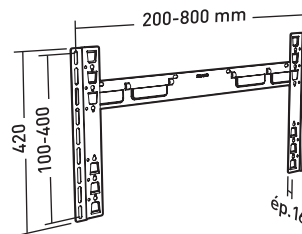
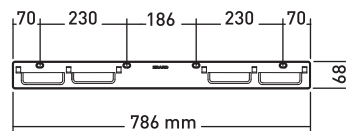

42° - 65°



70 KG



VESA 200 x 800x400



SLIM 16 mm

Ref. 045202

GENCOD 318528 045202 6



Ø 8 max

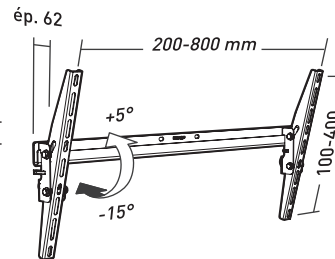
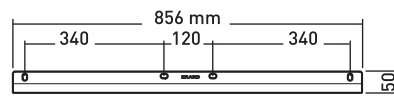

42° - 65°



70 KG



VESA 200 x 800x400



-15° / + 5°

Ref. 002532

GENCOD 318528 002532 9



Ø 8 max

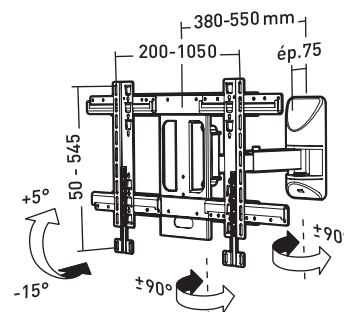
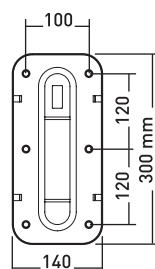

42° - 60°



60 KG



VESA 200 x 800x400



-15° / + 5°

ÉPI REPLIÉ : 120 mm

+/- 90°